

**cattelan
italia**

WESTIN GLASS

WESTIN WOOD

WESTIN KERAMIK PREMIUM

WESTIN WOOD-C

***ISTRUZIONI DI MONTAGGIO ASSEMBLING INSTRUCTIONS MONTAGEANLEITUNG
INSTRUCTIONS DE MONTAGE INSTRUCCIONES DE MONTAJE***

Cattelan Italia spa si riserva di apportare, senza preavviso, modifiche nei materiali, nei rivestimenti, nelle finiture e nei disegni dei prodotti presentati in questo catalogo. Le textures ed i colori dei materiali e delle finiture hanno valore indicativo in quanto soggetti alle tolleranze dei processi di stampa.

Cattelan Italia spa reserves the right to change, without previous notice, materials, covers, finishes and drawings of the products presented in this catalogue. The textures and colours of materials and finishes are indicative as they are depending on the tolerances of the printing process.

Cattelan Italia spa behält sich vor, ohne Vorankündigung, Veränderungen an den Materialien, Bezügen, Finish und Zeichnungen der in diesem Katalog vorgestellten Produkte vorzunehmen. Die Texturen und Farben der Materialien und Finish haben einen hinweisenden Wert, da sie von den Toleranzen im Druckprozess abhängig sind.

Cattelan Italia spa se réserve le droit d'apporter, sans préavis, des modifications au niveau des matériaux, des revêtements, des finitions et du design des produits présentés dans ce catalogue. Les textures et les couleurs des matériaux et des finitions sont une valeur indicative parce-que ils changent selon la tolérance aux procédés d'imprimerie.

Cattelan Italia spa se reserva el derecho de aportar modificaciones de dibujo, materiales, acabados y tapicerías, sin que esté obligada a dar aviso anticipado. Las textures y los colores de los materiales y de los acabados tienen solo un valor indicativo porque están sujetos a la tolerancia en los procesos de imprenta.

IMPORTANTE: Riporre per eventuali consultazioni future!!!!

IMPORTANT: File for future consultation!!!!

WICHTIG: Bitte aufbewahren für eventuelle spätere Nachfragen!!!!

IMPORTANT: A conserver pour les futurs besoins de référence!!!!

¡IMPORTANTE: Guardar para consultas posteriores!

WESTIN GLASS

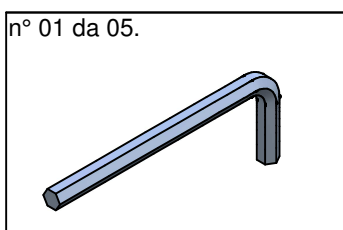
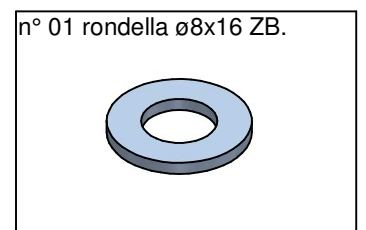
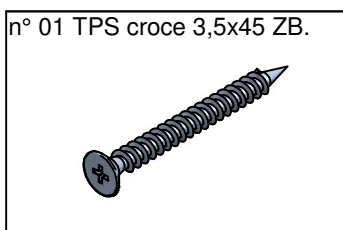
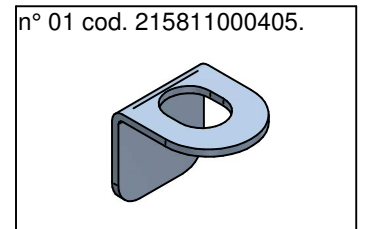
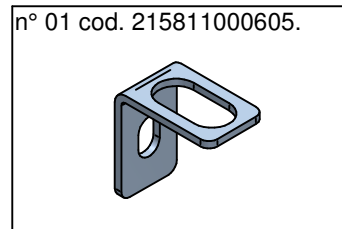
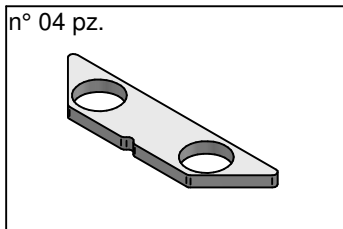
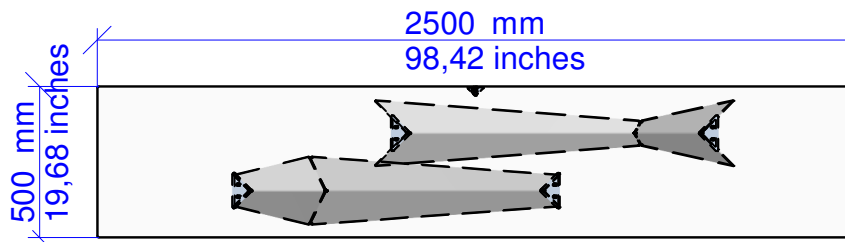
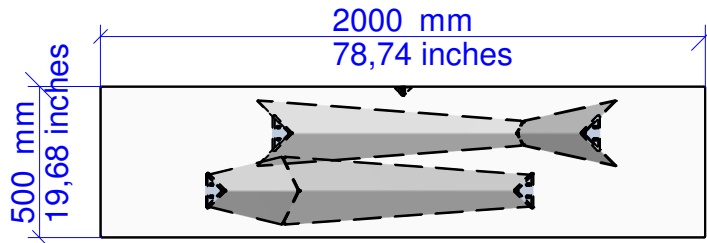
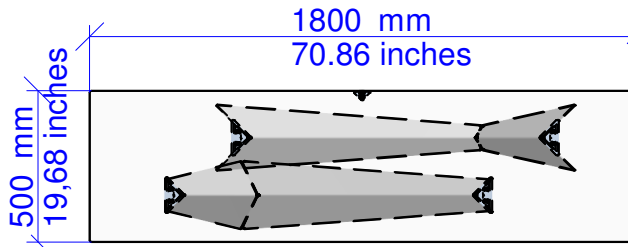
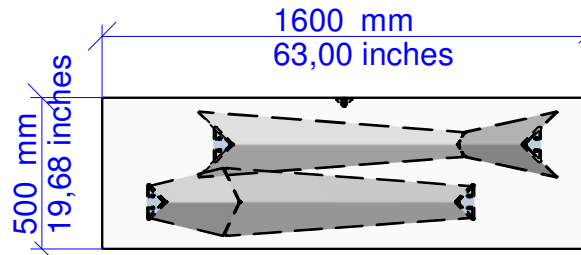
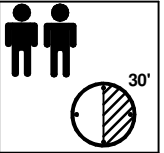

WESTIN WOOD

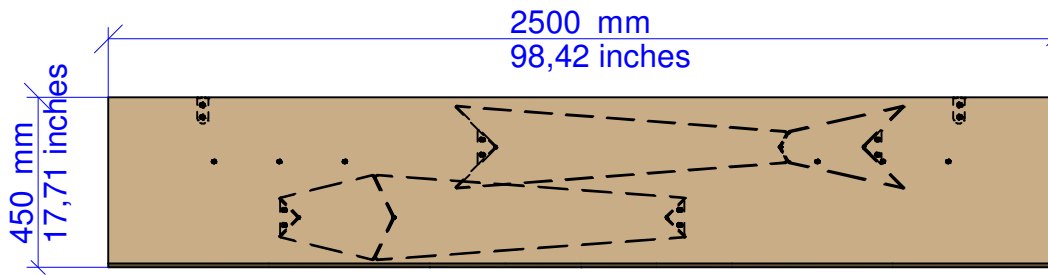
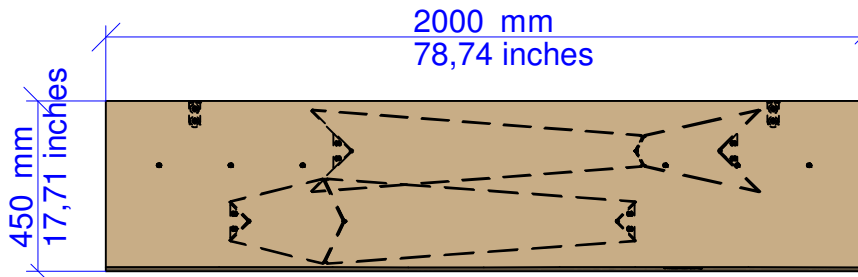
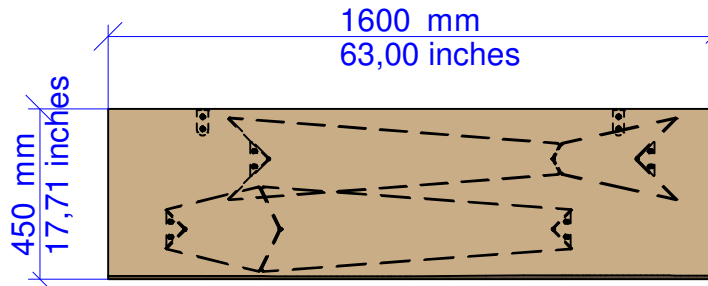
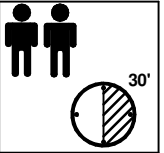

n° 08 TBCE M8x20 ZB.

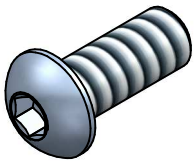

n° 08 rondella ø8x16 ZB.

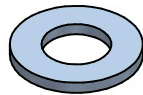

n° 02 cod. 215812000100.

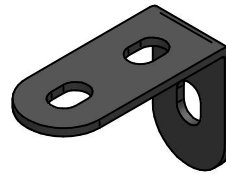

n° 04 TBCE M6x16 N.

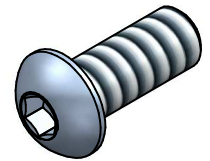

n° 06 rondella ø6x24 N.

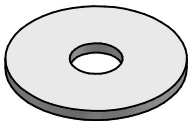

n° 02 MUNGO MN-S8x40.

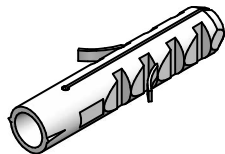

n° 02 TBCE M6x40 N.

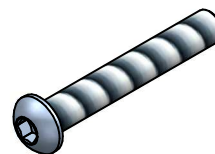

n° 01 da 04.

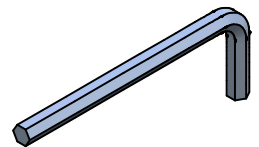

n° 01 da 05.

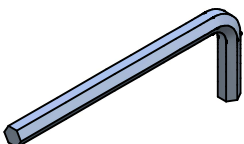

WESTIN KERAMIK PREMIUM

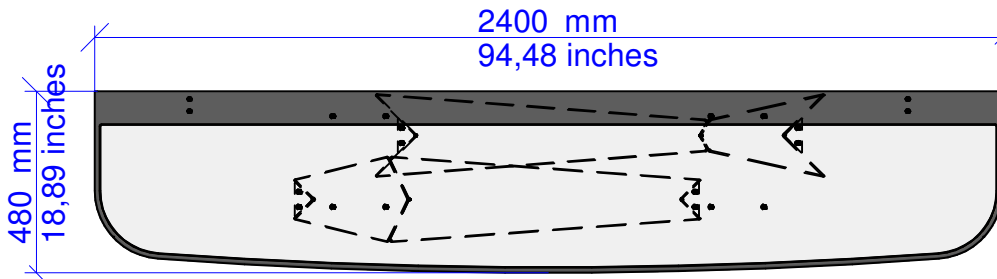
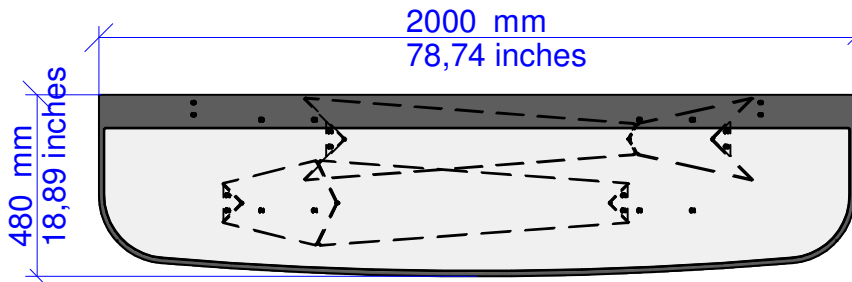
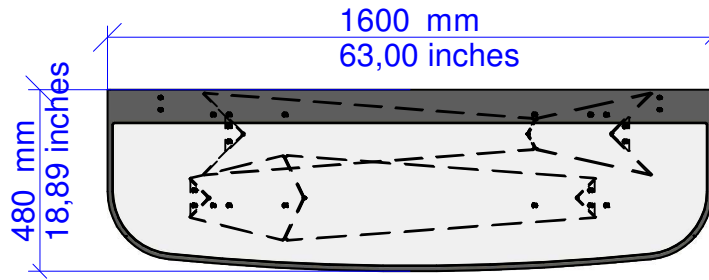
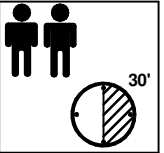

n° 08 TBCE M8x20 ZB.



n° 08 rondella ø8x16 ZB.

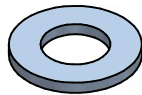

n° 02 cod. 215812000100.

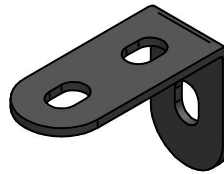

n° 04 TBCE M6x16 N.

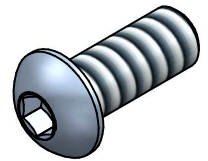

n° 06 rondella ø6x24 N.

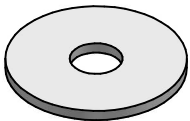

n° 02 MUNGO MN-S8x40.

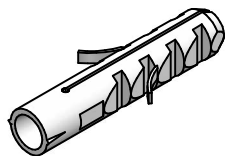

n° 02 TBCE M6x40 N.

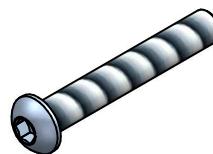

n° 01 da 04.

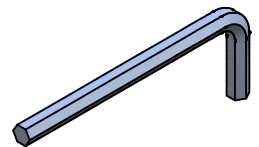

n° 01 da 05.

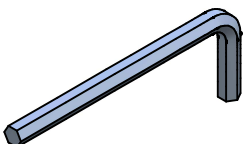

WESTIN WOOD-C

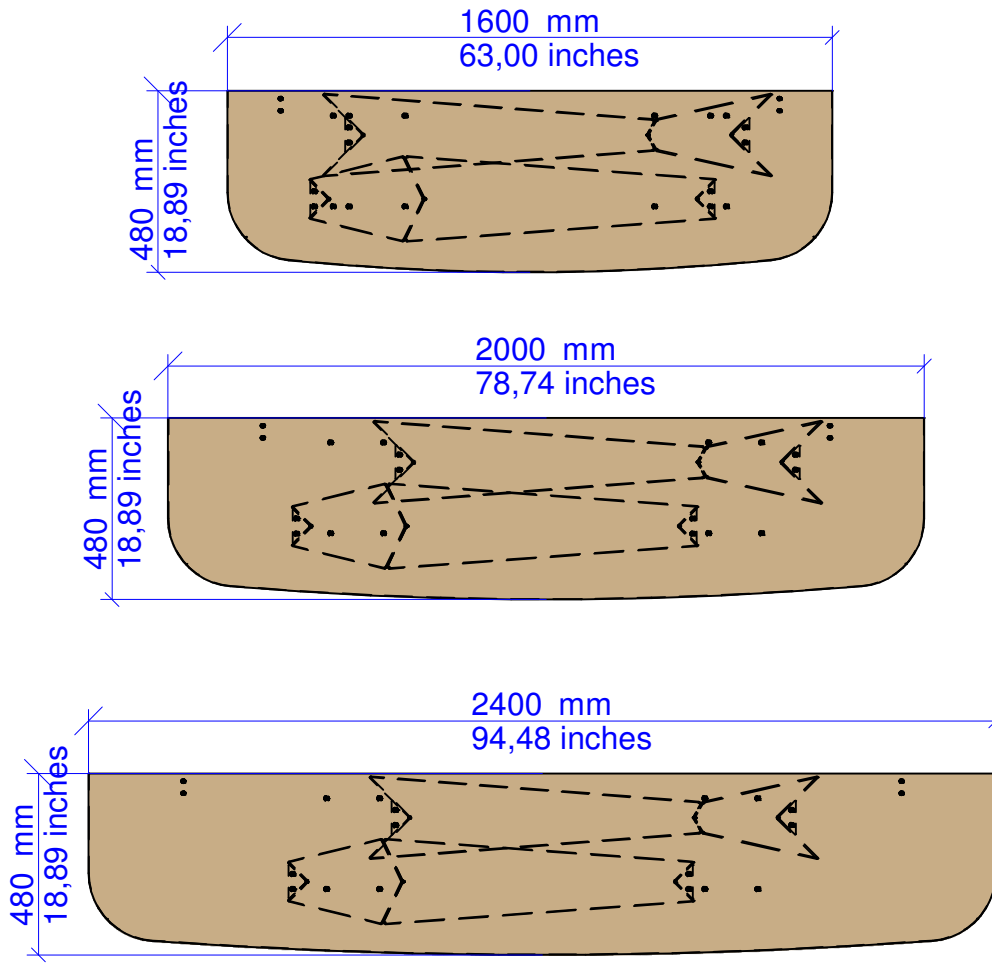
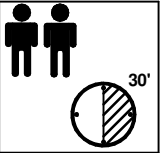

n° 08 TBCE M8x20 ZB.

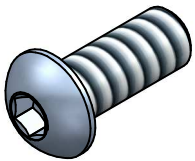

n° 08 rondella ø8x16 ZB.

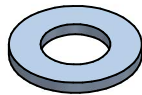

n° 02 cod. 215812000100.

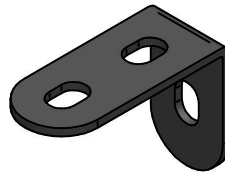

n° 04 TBCE M6x16 N.

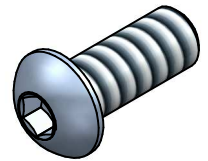

n° 06 rondella ø6x24 N.

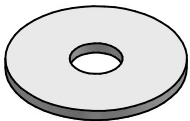

n° 02 MUNGO MN-S8x40.

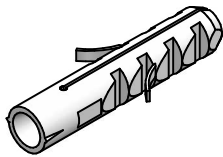

n° 02 TBCE M6x40 N.

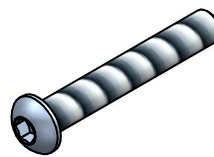

n° 01 da 04.

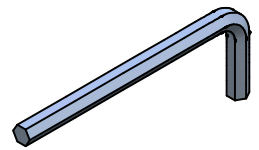

n° 01 da 05.

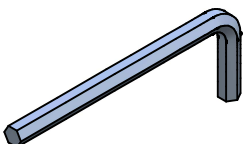

WESTIN GLASS

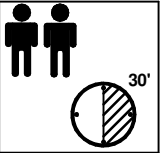

1 IMPORTANT!!!!-ACHTUNG!!!!-ATTENTION!!!!



**IMPORTANTE!!!!
WICHTIG!!!!
IMPORTANT!!!!
VERY IMPORTANT!!!!**

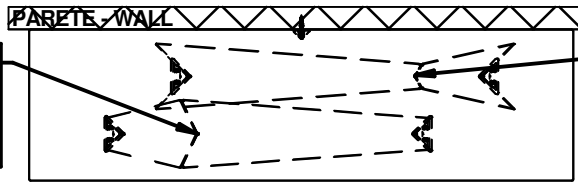

**IMPORTANTE!!!!
WICHTIG!!!!
IMPORTANT!!!!
VERY IMPORTANT!!!!**

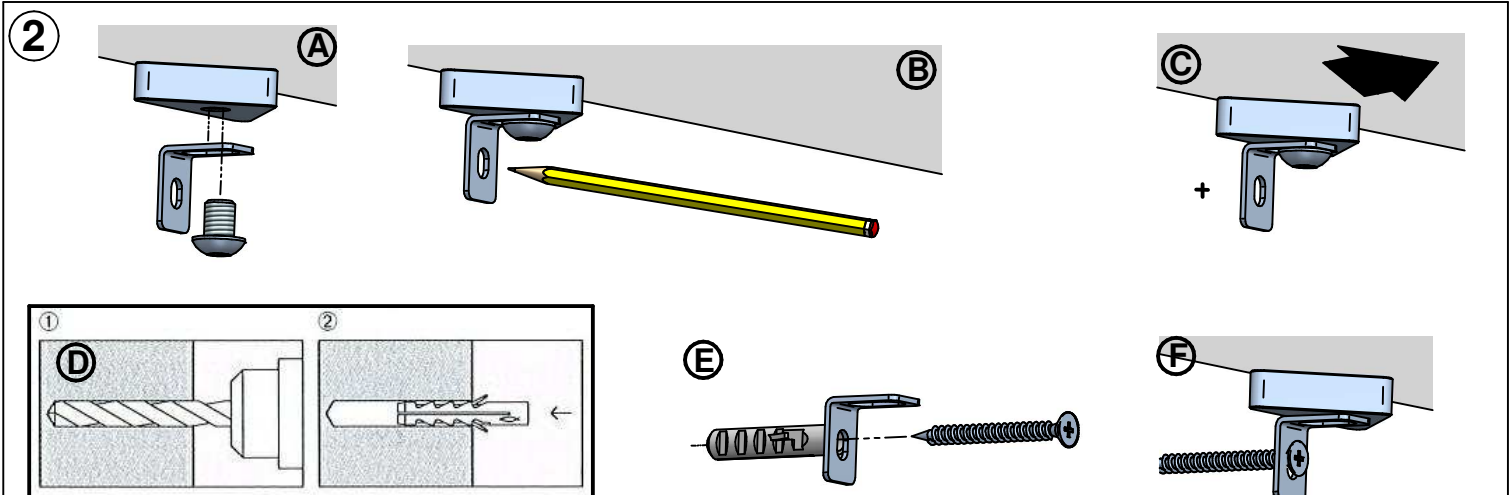
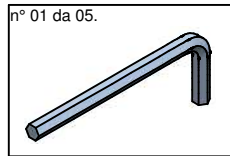
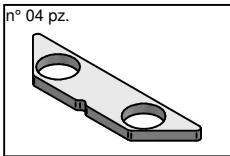
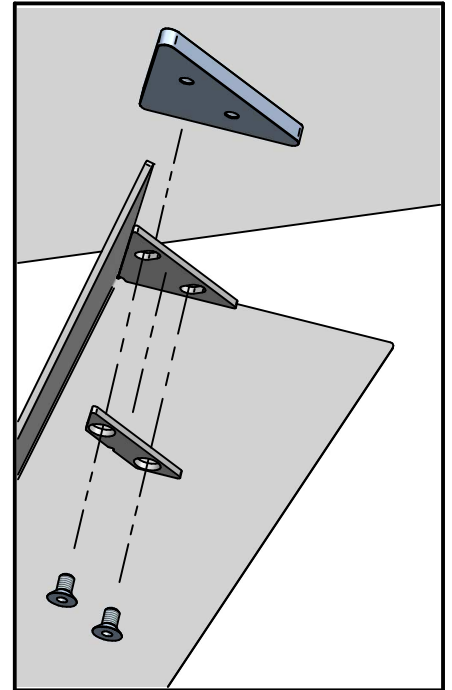
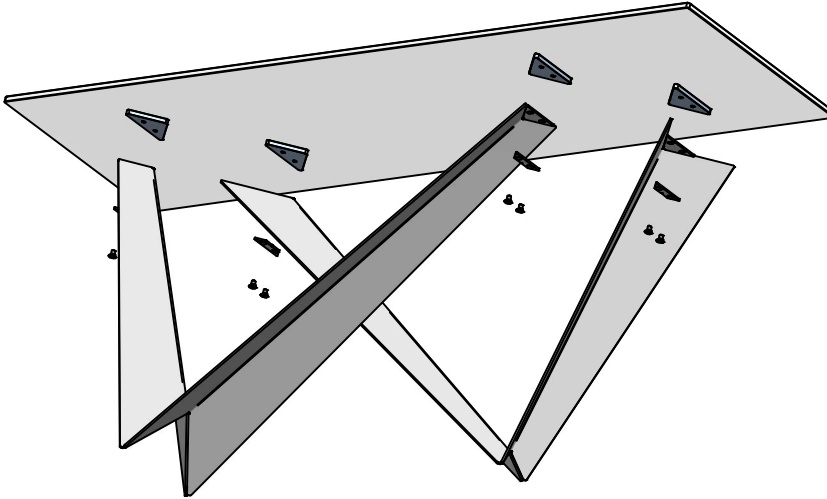

**Foro ø6 mm
Hole ø0,23 inches**

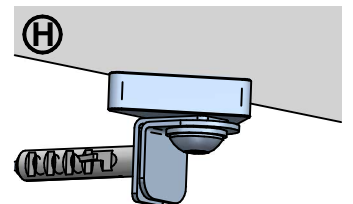
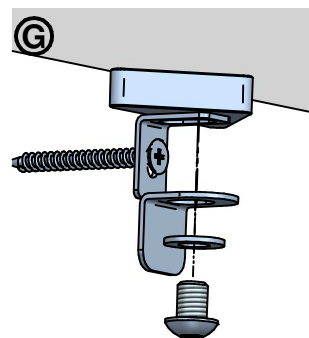
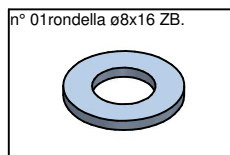
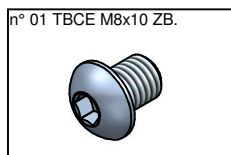
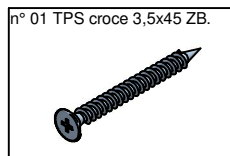
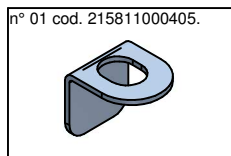
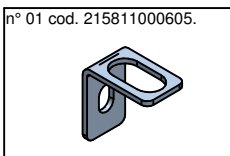

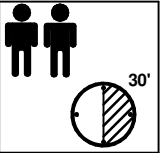

WESTIN WOOD

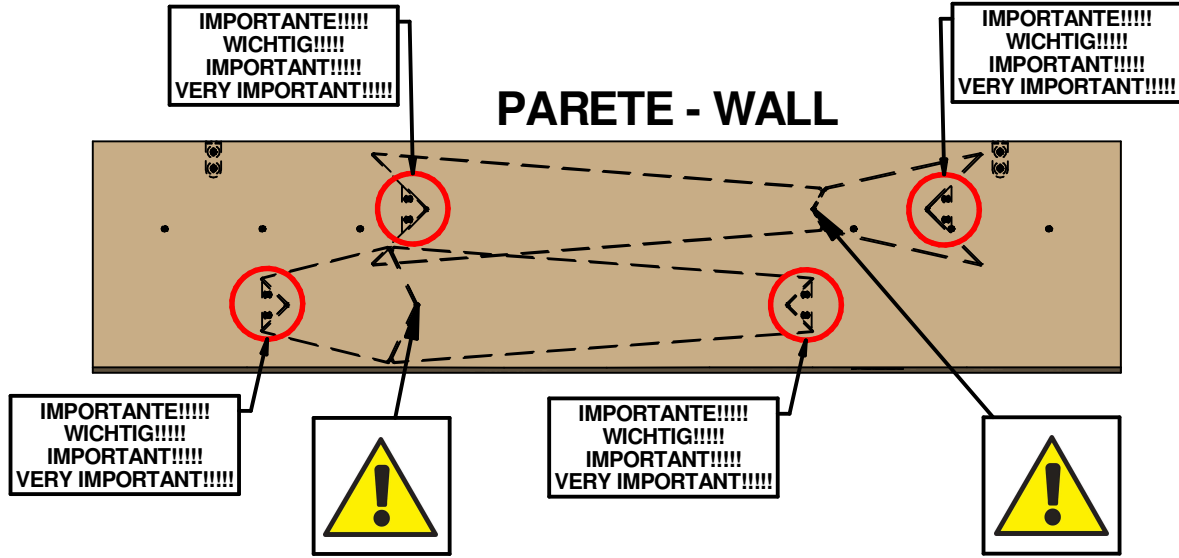

WESTIN KERAMIK PREMIUM

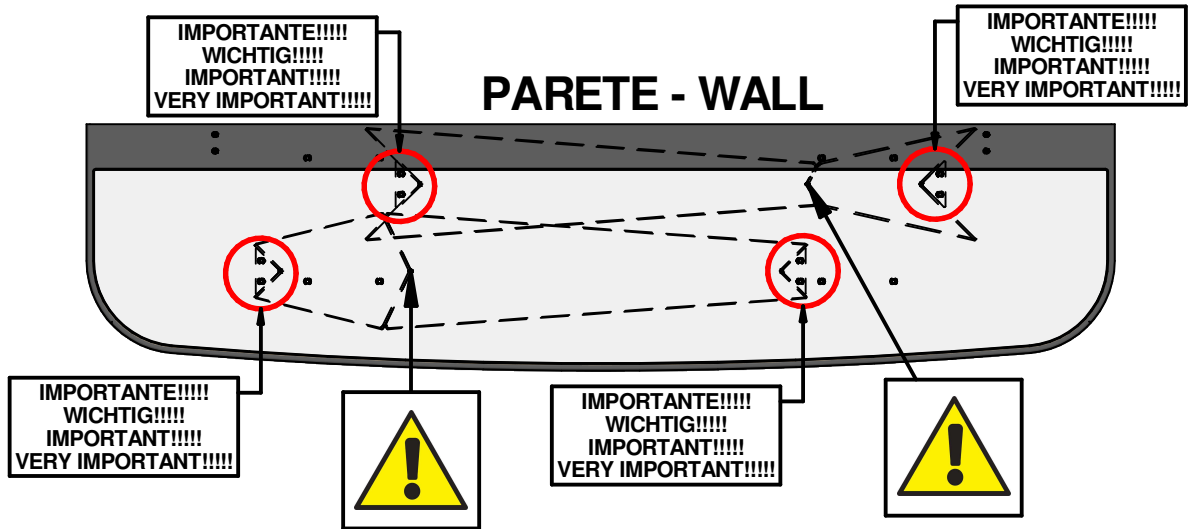

WESTIN WOOD-C

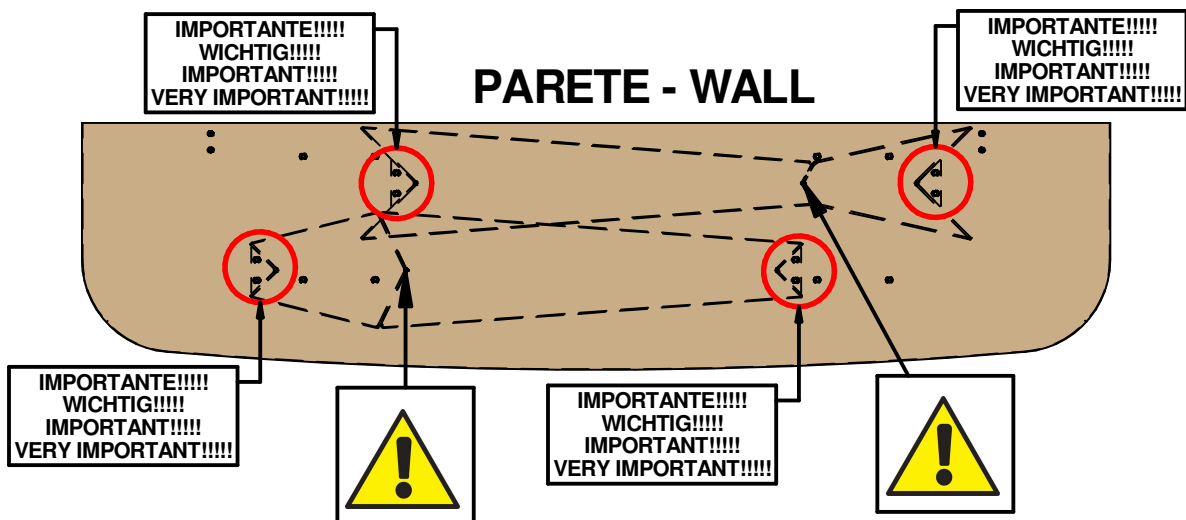

WESTIN WOOD - WESTIN KERAMIK PREMIUM WESTIN WOOD-C

1

**IMPORTANTE!!!!
WICHTIG!!!!
IMPORTANT!!!!
VERY IMPORTANT!!!!**

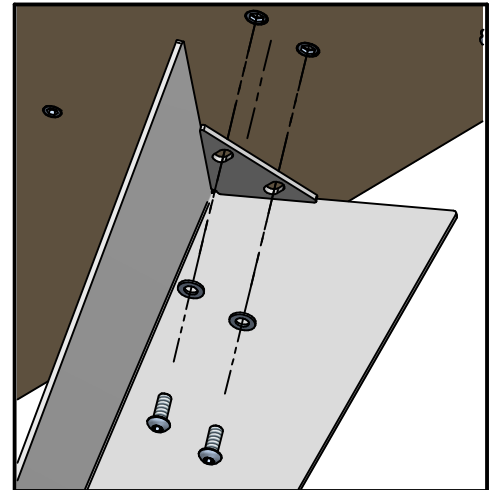
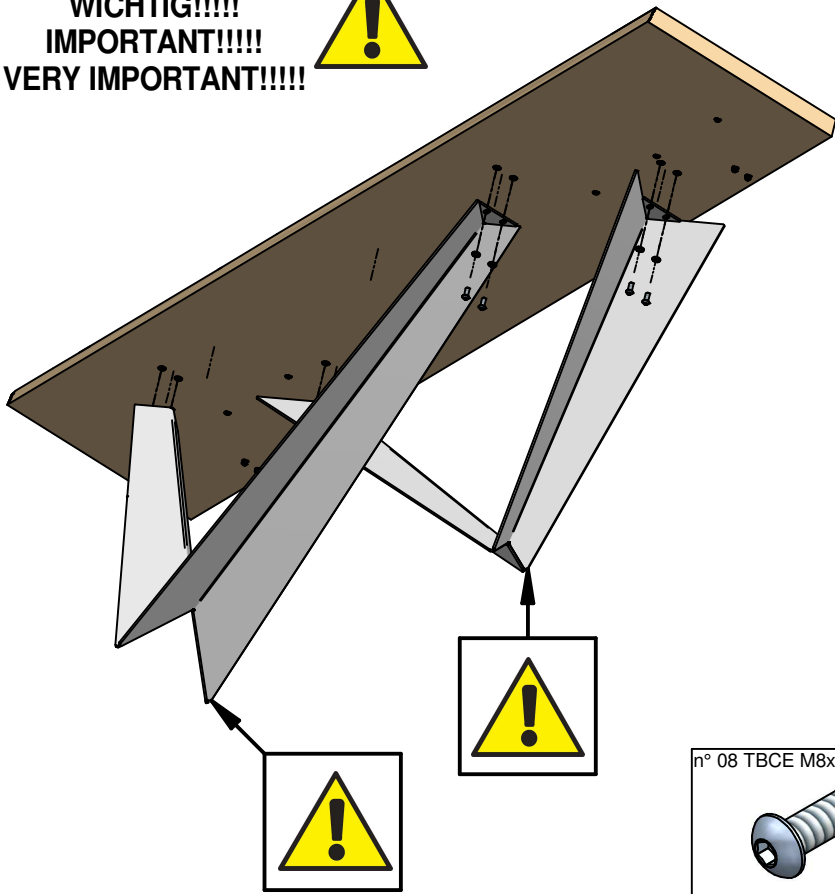

n° 08 TBCE M8x20 ZB.



n° 08 rondella ø8x16 ZB.

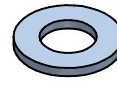

n° 01 da 05.



2

**IMPORTANTE!!!!
WICHTIG!!!!
IMPORTANT!!!!
VERY IMPORTANT!!!!**

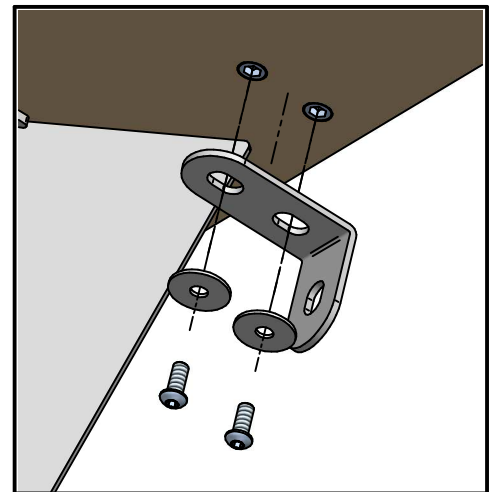
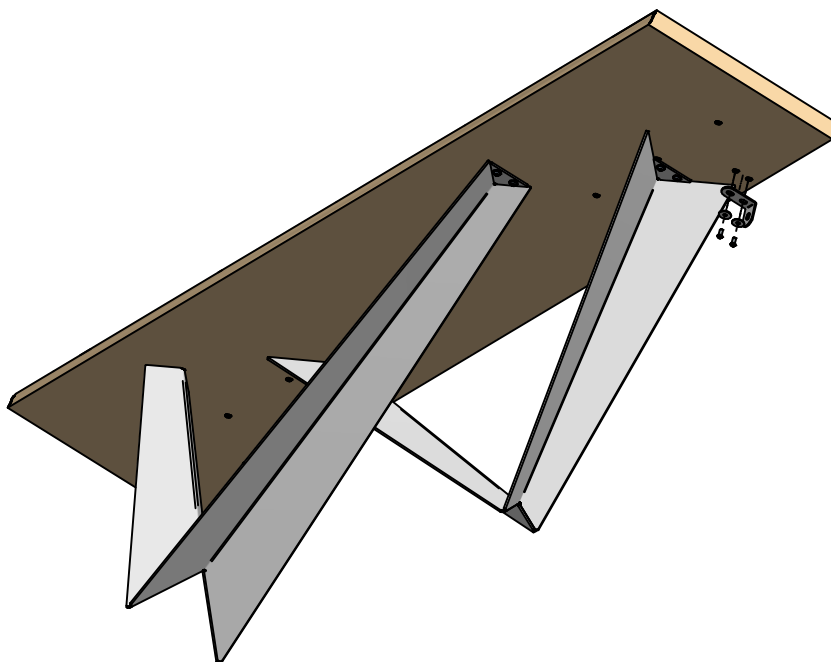

n° 02 cod. 215812000100.



n° 04 TBCE M6x16 N.



n° 04 rondella ø6x24 N.

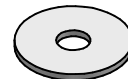

n° 01 da 04.



WESTIN WOOD - WESTIN KERAMIK PREMIUM WESTIN WOOD-C

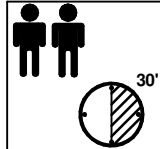

3

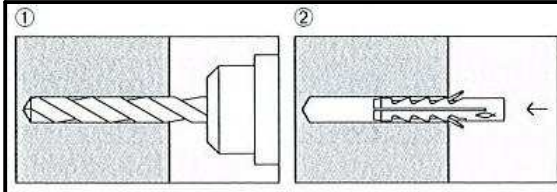
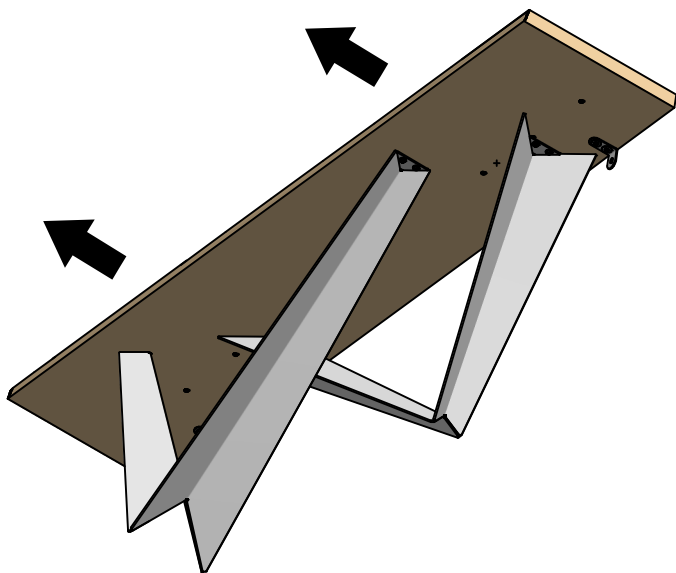
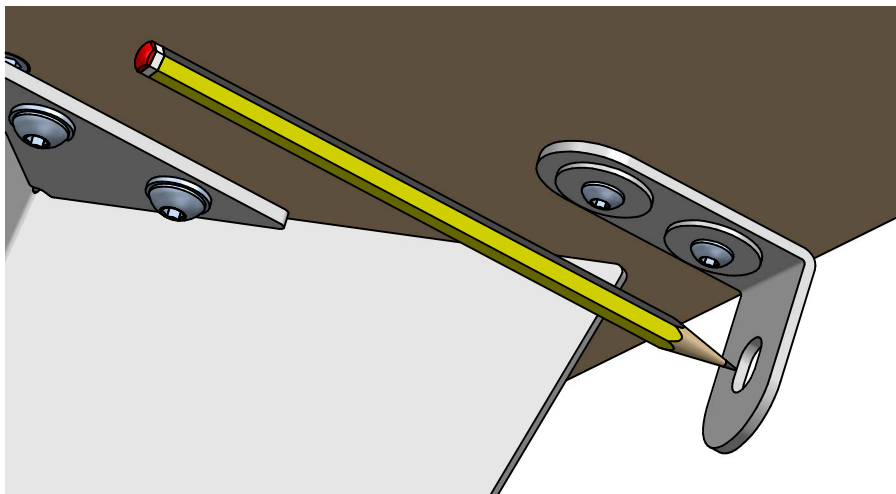

Foro ø8 mm
Hole ø0,31 inches

IMPORTANTE!!!!
WICHTIG!!!!
IMPORTANT!!!!
VERY IMPORTANT!!!!

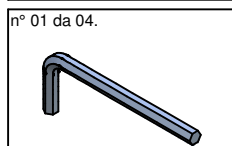
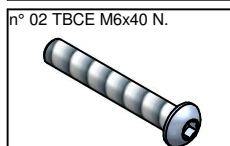
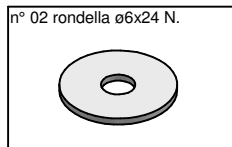
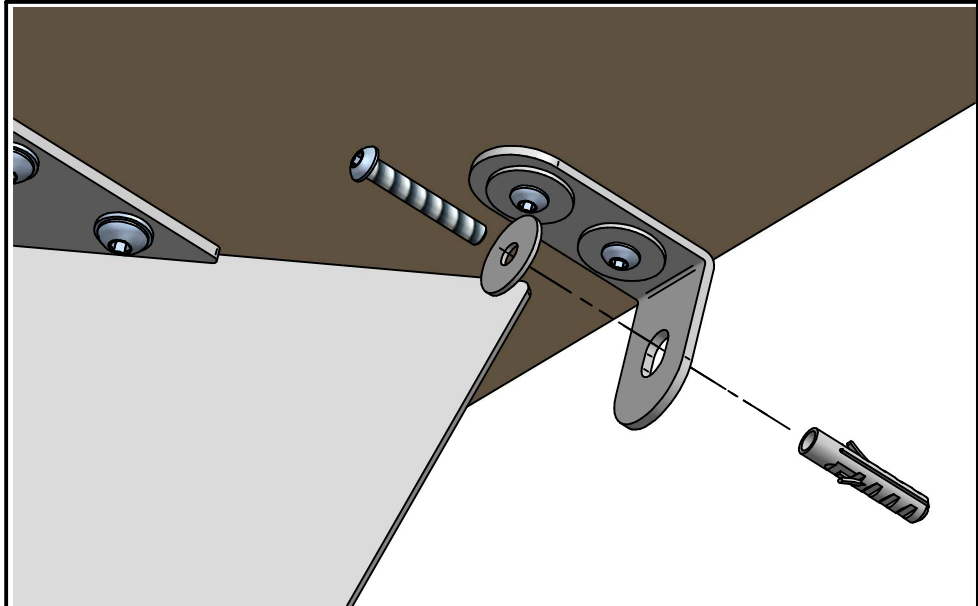

AVVERTENZE PER IL CLIENTE FINALE

USO

Il prodotto é destinato per l'utilizzo all'interno delle abitazioni con l'uso per il quale é stato realizzato.

MANUTENZIONE

Non vanno assolutamente utilizzati strumenti metallici appuntiti o panni abrasivi per eliminare eventuali residui di sporco presenti sulla superficie del prodotto, in quanto possono danneggiare la superficie stessa. Non vanno assolutamente utilizzati detersivi che contengano cloro o a base di acido cloridrico, acido muriatico o prodotti anticalcare in quanto andrebbero ad alterare la brillantezza del prodotto.

MANUTENZIONE LEGNO

Il legno é un materiale vivo e come tale può avere mutamenti nel tempo di colore e di dimensione, gli oggetti che vengono appoggiati sul piano, devono essere spostati periodicamente poiché il legno é sensibile alla luce e si ossida, creando differenze di colore tra le parti esposte alla luce e quelle coperte. Per la normale pulizia utilizzare un panno morbido leggermente umido. Non usare detersivi abrasivi, solventi, ammoniaci, acetone o petrolio. Per la rimozione di macchie utilizzare una soluzione di acqua e sapone neutro, avendo l'accortezza di asciugare subito le superfici bagnate.

ATTENZIONE

Non spostare assolutamente mai il prodotto trascinandolo o sollevandolo prendendolo per il piano ma smontarlo e riposizionarlo dove voluto, assicurandosi di proteggere le parti che si potrebbero danneggiare.

SMALTIMENTO

Una volta dismesso, il prodotto od i suoi componenti non vanno dispersi nell'ambiente ma conferiti ai sistemi pubblici di smaltimento.

INSTRUCTIONS FOR THE END CUSTOMER

USE

The product is intended to be used in the inside and for the purposes it was created for.

MAINTENANCE

It is recommended not to use metal sharp tools or abrasive clothes to eliminate dirt from the surface, because they could damage the same. Do not absolutely use detergents containing chlorine, muriatic acid, hydrochloric acid or descale detergents which can damage the surface brilliance.

MAINTENANCE WOOD

Wood is a living material and therefore susceptible to slight colour and dimension changes. As the wood is sensitive to light and oxidizes, any item standing in the same place on the top for a long period of time can create colour differences between the covered and the exposed parts, so they should be moved periodically. Clean it with a slightly damp soft cloth. DO NOT use any chemicals or harsh detergents such as ammonia. To remove stains, wash the top with mild soap and water, and rinse. Dry the top thoroughly.

WARNING

Do not absolutely move the product dragging it or lifting it by gripping the top, but disassemble it and then place it in the new site, protecting the parts that could be damaged.

DISPOSAL

Once discarded, neither the product nor its components should be dispersed in the environment, but rather consigned to public disposal systems.

HINWEISE FÜR DEN ENDKUNDEN

NUTZUNG

Das Produkt ist nur für den Innenbereich gedacht. Der Tisch wurde hergestellt, nur als Esstisch genutzt zu werden.

WARTUNG

Niemals scharfe Werkzeuge aus Metall, spitzen Instrumente oder Schleifmittel für die Reinigung der Oberfläche verwenden. Diese Produkte können die Oberfläche beschädigen. Niemals Chemikalien mit chlorhaltigen Salzsäure, Salzsäure oder Kalk-Produkte für die Reinigung verwenden. Diese Produkte können der Glanz beschädigen.

PFLEGE DES HOLZES

Holz ist ein lebendes Material und kann sich in der Farbe und Größe ändern. Objekte, die auf die Platte gestellt werden, müssen periodisch bewegt werden, da Holz lichtempfindlich ist und oxidiert und dadurch die Farbe ändert. Für die normale Reinigung genügt ein weiches, feuchtes Tuch. Bitte kein Scheuermittel, Lösungsmittel, Ammoniak, Aceton oder Öl verwenden. Zum Entfernen von Flecken milde Seife und Wasser benutzen, die nassen Oberflächen sofort abtrocknen.

ACHTUNG

Der Tisch absolut nie ziehen oder heben. Falls der Tisch soll bewegt werden, muss zerlegt werden und sorgfältig in der neue Stelle positioniert. Die empfindliche Teile sollen geschützt werden.

ENTSORGUNG

Nach der Aussonderung ist das Produkt und seine Bestandteile nicht selbständig im Freien zu entsorgen, sondern der städtischen Müllabfuhr zu übergeben.

INSTRUCTIONS POUR LE CLIENT FINAL

UTILISATION

Le produit est destiné pour une utilisation à l'intérieur des habitations.

MANUTENTION

Il ne faut pas absolument utiliser des outils pointus ou des chiffons abrasifs pour éliminer des possibles restes sur la surface du produit, parce qu'ils peuvent endommager la surface même. Ne pas utiliser des détergents contenant du chlore, acide chlorhydrique, acide muriatique ou produits anticalcaire qui peuvent altérer le brillant du produit.

ENTRETIEN BOIS

Le bois est une matière qui vit, et comme tel il peut avoir des changements de couleur, de dimension, les objets posés sur le plateau doivent être posés de façon intermittente car la sensibilité à la lumière peut créer des différences de ton entre les parties du plateau couverte ou non par les objets. Pour l'entretien, utilisez un chiffon doux et légèrement humide. Ne pas utiliser de revêtements abrasifs, ammoniac ou autre détergeant. Pour enlever les taches utiliser de l'eau et du savon neutre, en essayant immédiatement les parties concernées.

ATTENTION

Ne pas absolument déplacer le produit en le traînant ou en le soulevant par le top, mais démontez-le et positionnez-le autre part, en s'assurant de protéger les parties qui pourraient s'endommager.

ECOULEMENT

Une fois disloqué, le produit ou ses composants ne doivent pas être dispersés dans la nature mais confiés aux décharges publiques.

INSTRUCCIONES PARA EL CLIENTE FINAL

USO

El producto está destinado para su uso dentro del hogar, a los fines por los cuales fue creado.

MANTENIMIENTO

No utilizar en cualquier forma instrumentos de metal afilados o telas abrasivas para eliminar cualquier resto de suciedad en la superficie del producto, ya que pueden dañar la superficie misma. No utilizar en cualquier forma limpiadores a base de cloro o que contienen ácido clorhídrico, ácido muriático o productos anticalcáreos ya que pueden alterar el brillo del producto.

MANTENIMIENTO MADERA

La madera es un material vivo y, como tal, puede tener cambios con el tiempo de color y tamaño, los objetos que se colocan en el sobre, se deben mover periódicamente ya que la madera es sensible a la luz y se oxida, creando diferencias de color entre las piezas expuestas a la luz y las cubiertas. Para la limpieza normal, use un paño suave ligeramente humedecido. No use limpiadores abrasivos, disolventes, amoníaco, acetona y aceite. Para quitar las manchas utilizar una solución de jabón suave y agua, asegurándose de secar las superficies mojadas inmediatamente.

ATENCIÓN

No muevan absolutamente nunca el producto arrastrándolo o mediante el levantamiento del plano, sino desmontarlo y llevarlo a donde querían, asegurándose de proteger las partes que pueden dañarse.

ELIMINACIÓN DE DESECHOS

Una vez desechado, el producto o sus componentes no se tienen que abandonar en el entorno sino entregar al sistema público de recogida de basuras.

**cattelan
italia**

CATTELANITALIA.COM



CATTELAN ITALIA SPA – via pilastri 19 – 36010 Carré / Vicenza – Italy
phone +39 0445 318711 - fax +39 0445 314289 - email: info@cattelanitalia.com