

QUASAR

H O L L A N D



Universe

NL Installatie handleiding

DE Installationsanleitung

EN Installation manual

1 NL Informatie / DE Information/ EN Information

Veiligheidsinformatie



- Onderbreek altijd de stroomtoevoer door verwijderen van de toestelzijdige stop bij de montage, onderhoudswerk en het verwisselen van de gloeilampen.
- Een brandende lamp is heet. Let op brandgevaar.
- De lamp mag niet op geleidend materiaal worden gemonteerd.

- Draag geen sieraden bij onderhoudswerkzaamheden.
- Geen (decoratie) materialen aan het armatuur bevestigen.

Technische informatie



- Ingangsspanning 120V of 240V
- Uitgangsspanning 12V
- Beschermingsklasse I
- Beschermingsgraad IP20
- De lamp mag niet in openlucht gebruikt worden
- LED: 12V, 0.33W, 2600K, CRI >83
- Ten minste een afstand van 0,5m tenopzichte van het bestraalde oppervlakte houden.
- Technische gelijkvormigheid volgens EN-Richtlijnen



Onderhoudsinformatie



- De lampen reinigen met in de handel verkrijgbare, niet-agressieve en niet-schurende reinigingsmiddelen
- Gebruik een plumeau

Sicherheitshinweise

- Bei Montage, Wartungsarbeiten und Leuchtmittelwechsel immer Stromzufuhr durch Entfernen der bauseitigen Sicherung unterbrechen.

Wenn die Leuchte in Betrieb ist, besteht beim Glühmittel Verbrennungsgefahr!

- Leuchte darf nicht auf leitende Materialien montiert werden.
- Kein Juwelen während wartung tragen.
- Kein (dekorations) Materialien an die Leuchte befestigen.

Technische Hinweise

- Eingangsspannung 120V oder 240V
- Ausgangsspannung 12V
- Schutzklasse I
- Schutzart IP20
- Leuchte darf nicht im Freien verwendet werden.
- LED: 12V, 0.33W, 2600K, CRI >83
- Mindestabstand zur angestrahlten Fläche 0,5m
- Technische Konformität gemäss EU-Richtlinien

Pflegehinweise

- Leuchten nur mit handelsüblichen, nicht aggressiven und scheuernden Reinigungsmitteln reinigen.
- Gebrauch eine Federbesen

Safety information

- During installation, maintenance work and change of illuminants always interrupt the power supply by removing the respective circuit breaker.

When switched on, the lamp may cause burns when touched.

- Lamp may not be mounted on conductive materials.
- Don't wear jewelry during maintenance.
- Don't use decoration materials in the lamp.

Technical data

- Input voltage 120V or 240V
- Output voltage 12V
- Safety class I
- Degree of protection IP20
- Lamp must not be used in the open.
- LED: 12V, 0.33W, 2600K, CRI >83
- Minimum distance from illuminated surface 0.5m
- Technical conformity according to European EN-Regulations

Maintenance information

- Lights should only be cleaned using commercially available, non-aggressive, non-scouring cleaning agents.
- Use a feather duster

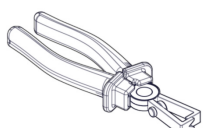
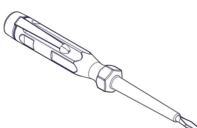
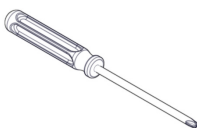
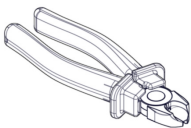
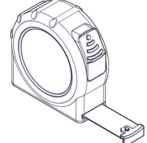
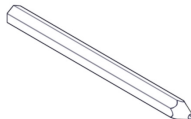
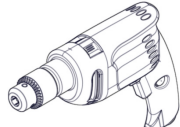
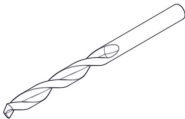

2.1 NL Installatie / EN Installation / DE Installation

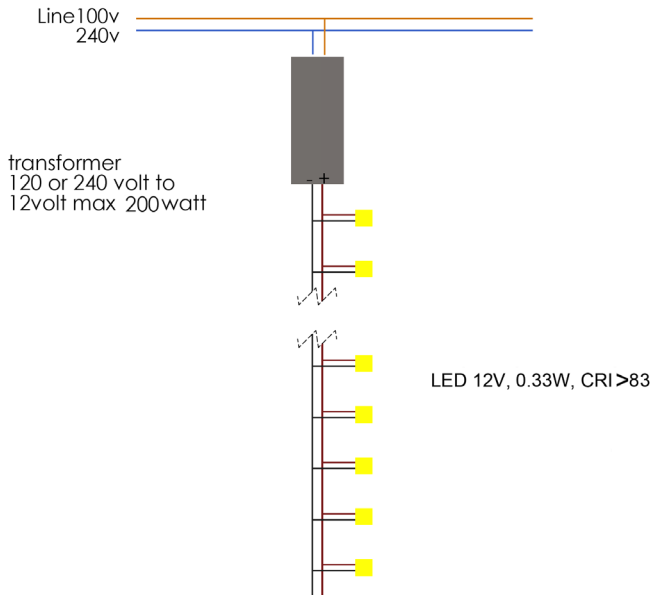

2.2

Universe 80 suspension

- 35x LED: E10 12V/0,33W= 11,55 W
-x Downlight 12V/3W= W

Universe 125 suspension

- 50x LED: E10 12V/0,33W= 16,5 W
-x Downlight 12V/3W= W

Universe 180 suspension

- 60x LED: E10 12V/0,33W= 19,8 W
-x Downlight 12V/3W= W

Universe 200 suspension

- 70x LED: E10 12V/0,33W= 23,1 W
-x Downlight 12V/3W= W

Universe custom suspension

-x LED: E10 12V/0,33W= W
-x Downlight 12V/3W= W



2.3 NL Installatie / EN Installation / DE Installation

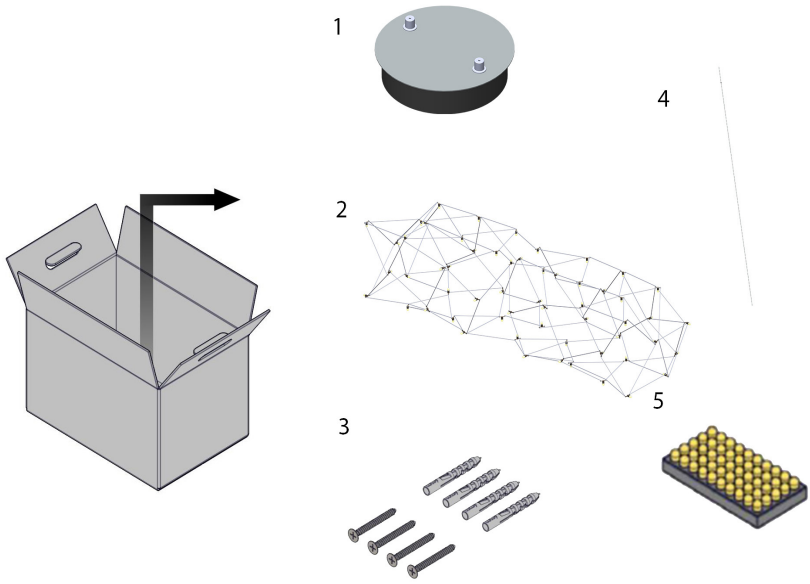

2.4

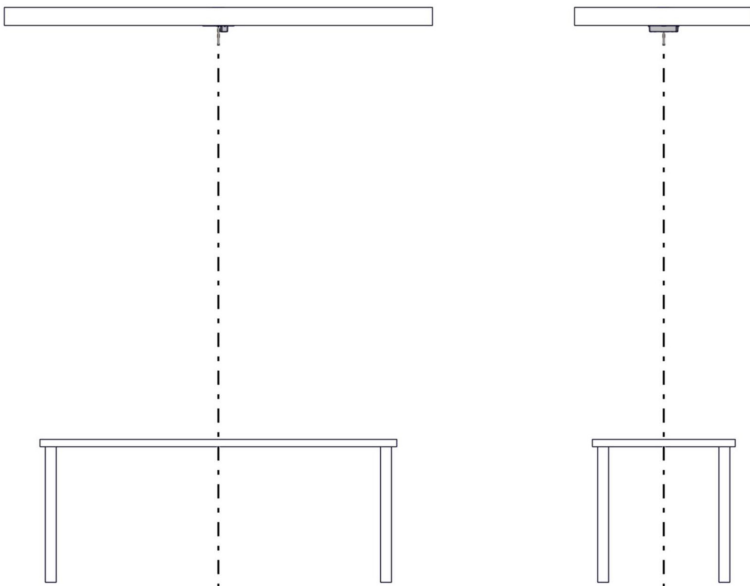

2.5 NL Installatie / EN Installation / DE Installation

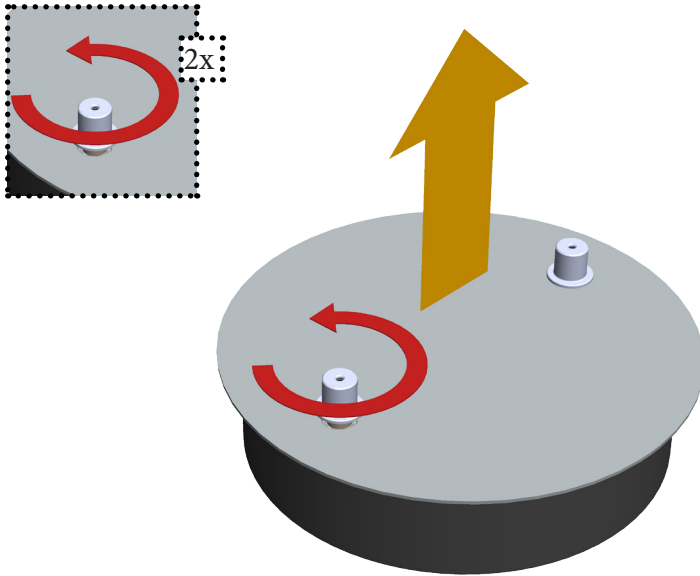

2.6

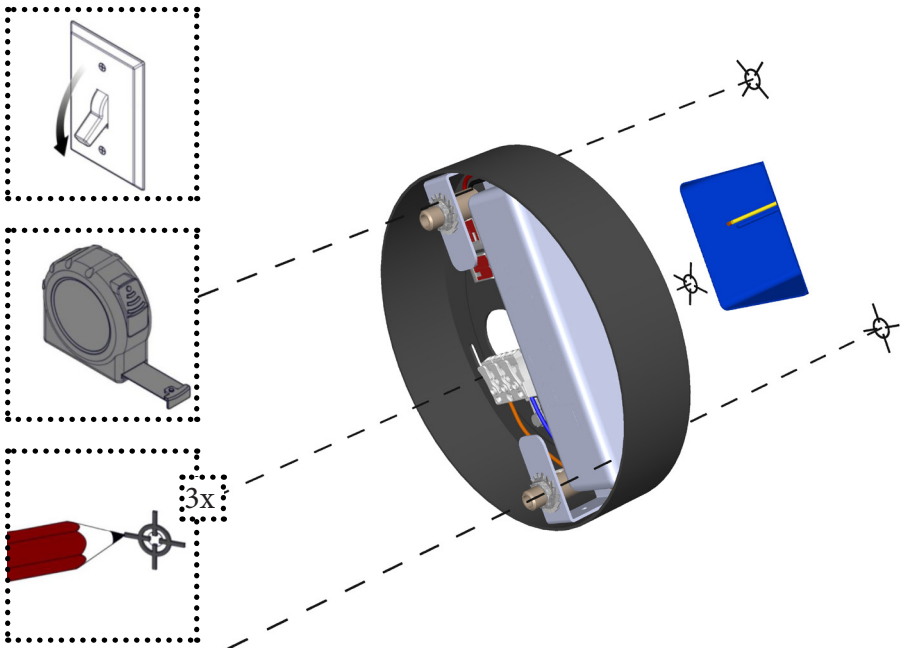

2.7 NL Installatie / EN Installation / DE Installation

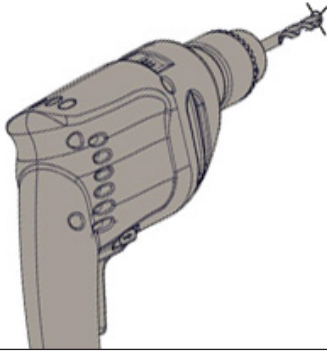
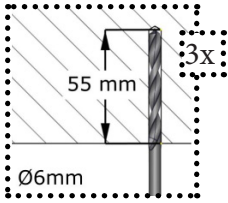

2.8

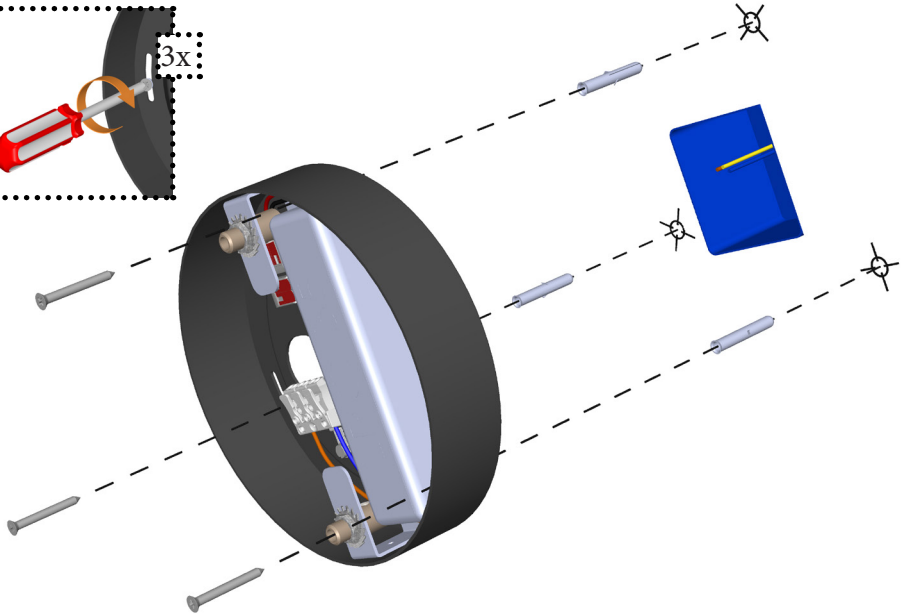
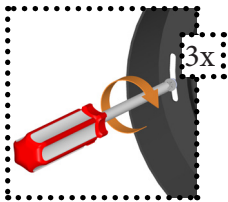

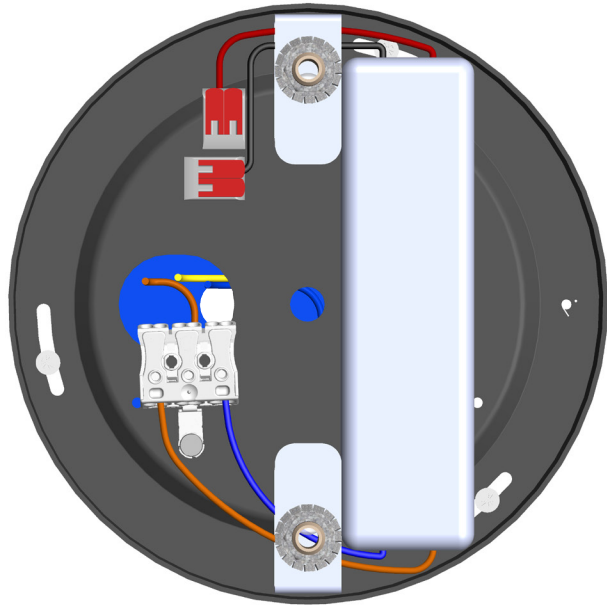
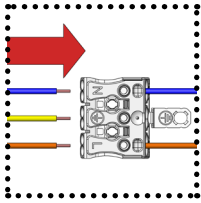

2.10

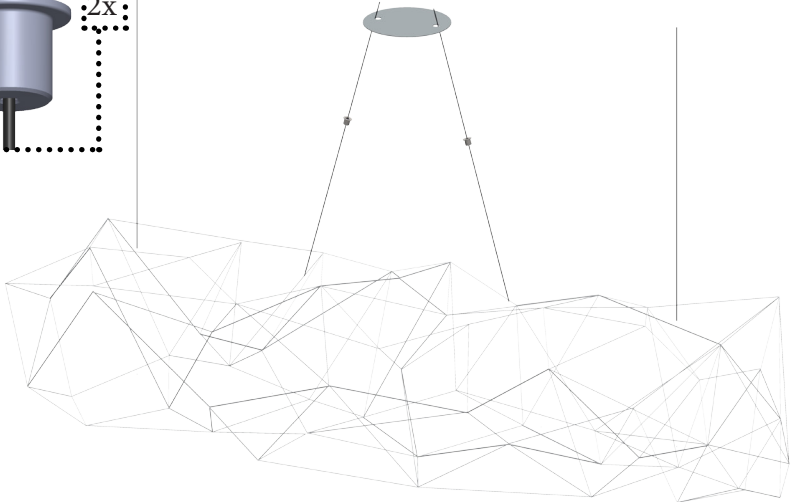
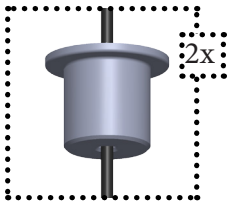

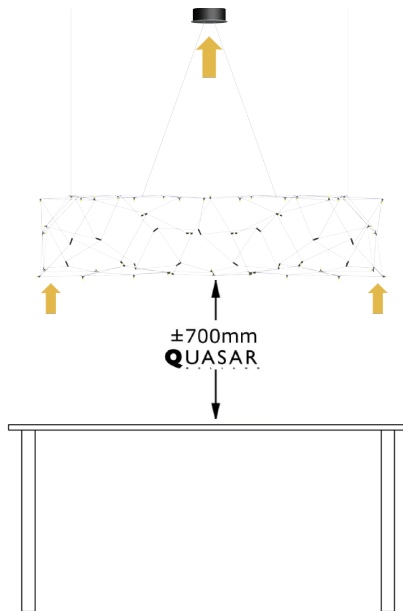
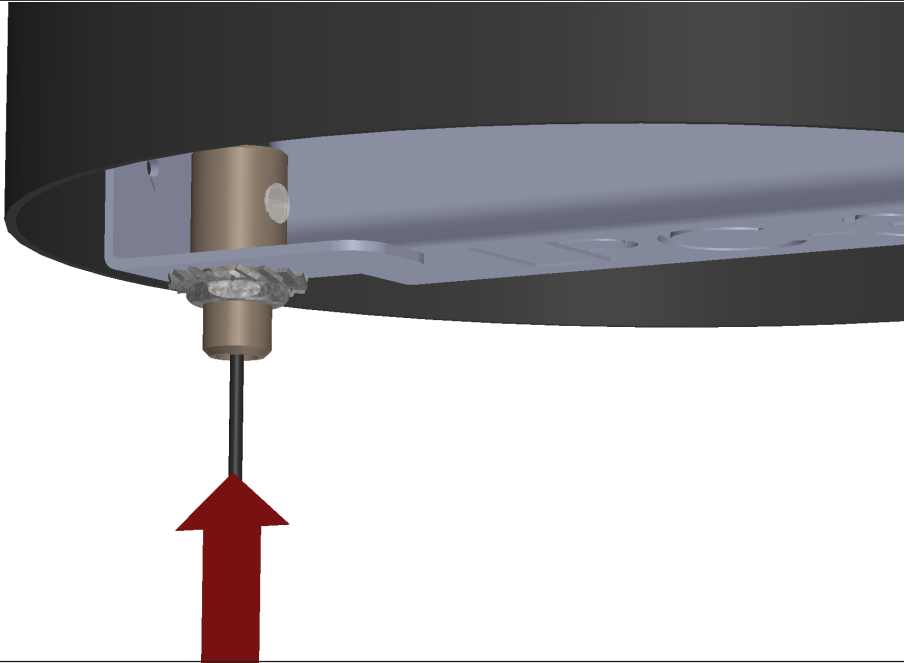

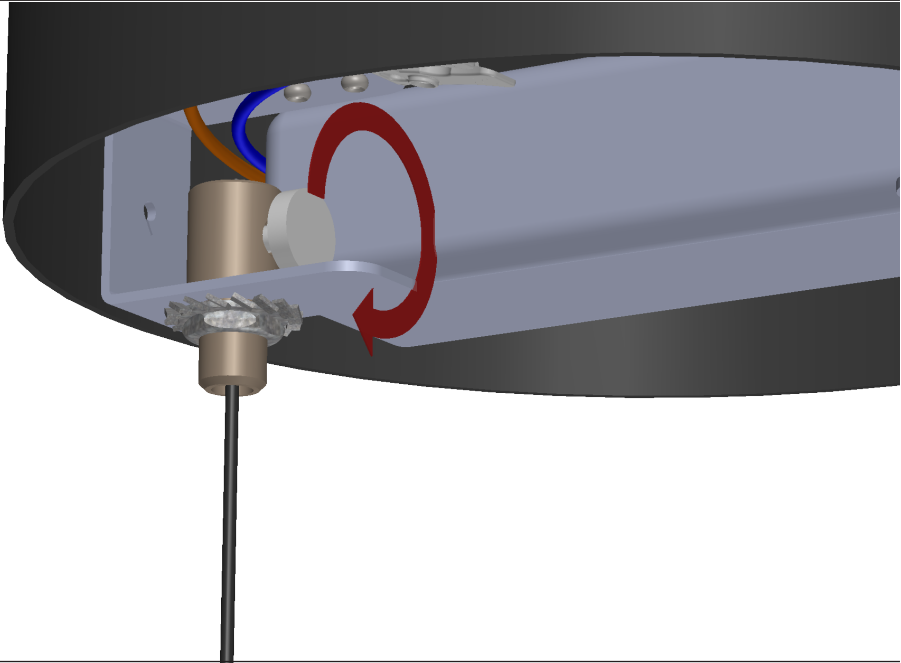

2.14

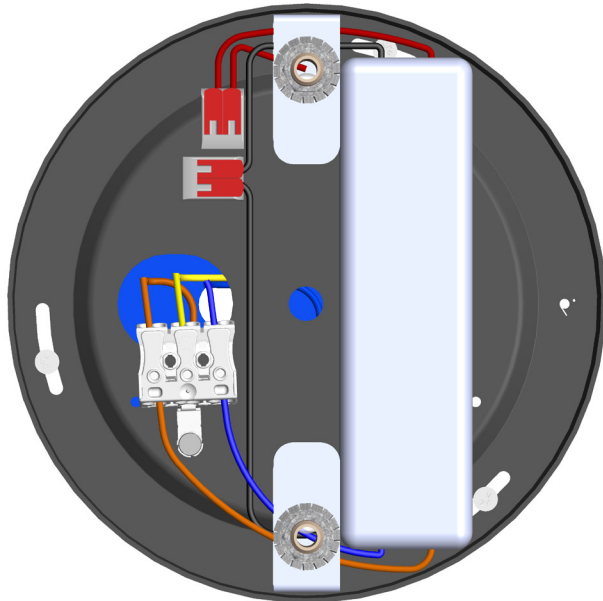
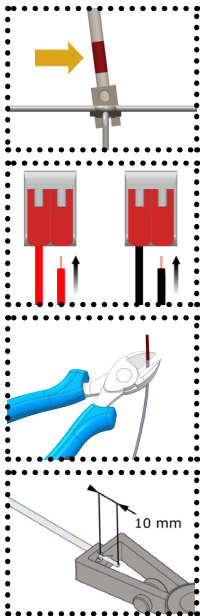



2.15 NL Installatie / EN Installation / DE Installation

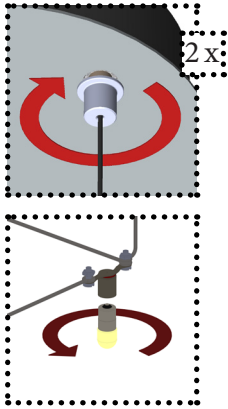

2.16

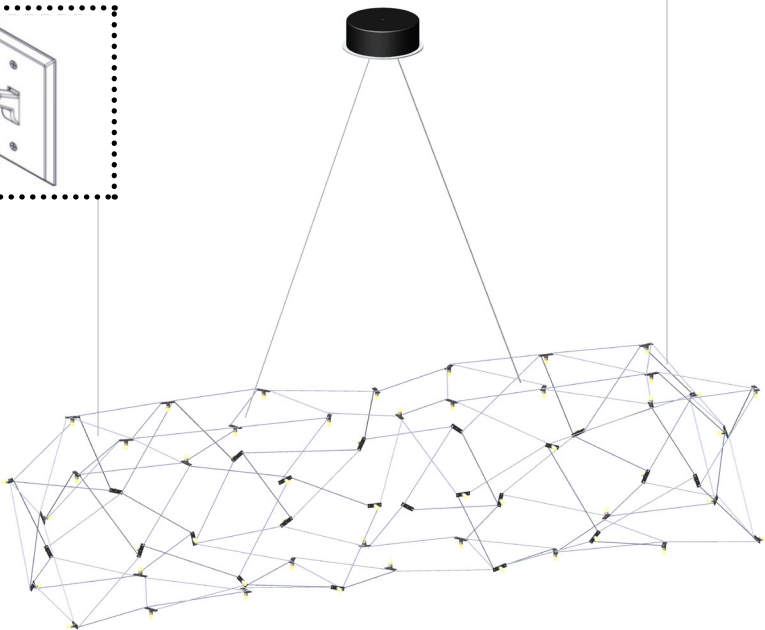
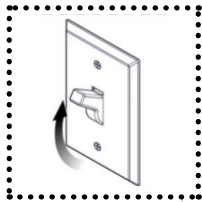

Lined area for writing, consisting of 23 horizontal lines.



Quasar Holland B.V.
Burgstraat 2
4283 GG GIESSEN
THE NETHERLANDS

T. 31-183-447887
E. info@quasar.nl
I. www.quasar.nl

Date: 18-02-2021
Version: 3