

Mito alto side 70 datasheet

Linear LED ceiling light with single-sided light emission and length of 70.5 cm. With the sidelight (wallwash) wall surfaces can be illuminated homogeneously without causing any glare.

Version with integrated power supply unit and cover (optional) for mounting on plaster surfaces; connection to 230 VAC mains voltage. Dimmable via trailing-edge phase-cut dimmer*; can alternatively be controlled via Occhio air or DALI. The colour temperature can be preset (2700/3000/3500/4000 K) or can be continuously controlled from 2700 to 4000 K via Occhio air or DALI.

Other version: Mito alto flat (40/70/100), Mito alto up (40/70/100), Mito alto side (40/100), Mito volo fix flat (100/140), Mito volo var up (100/140), Mito volo fix up (100/140), Mito volo fix up midfeed (100/140)

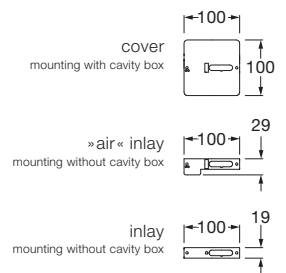
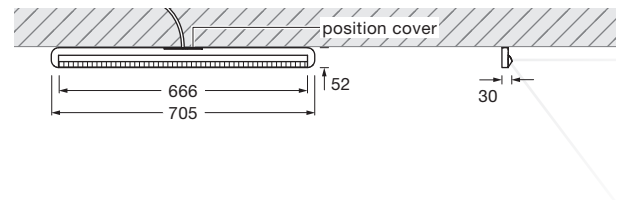
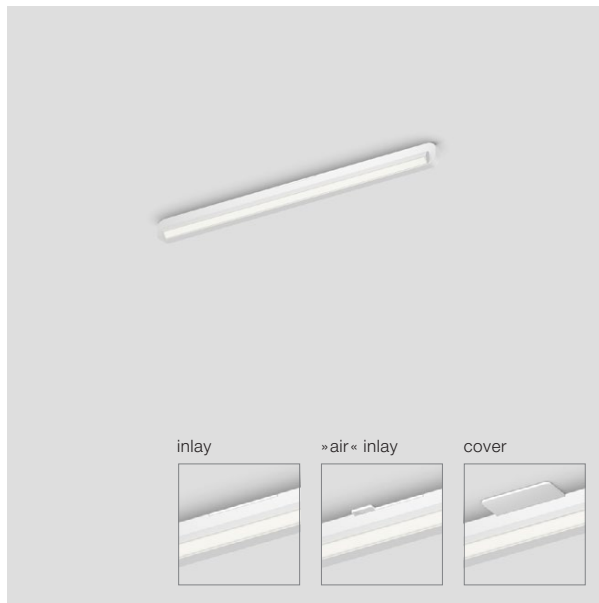

incl. power supply unit

dimensions in mm

technical data Mito alto side 70

properties	material	head aluminium, painted, PVD-coated steel, optical plastic cover painted plastic
	recommended wall clearance for homogeneous wall illumination	approx. 70 cm for 250 cm ceiling height approx. 85 cm for 300 cm ceiling height
	weight	1.6 kg
surface	head	bronze, matt gold, rose gold, matt silver, matt white, matt black
	cover	matt white, matt silver, matt black
Occhio »color tune« LED	average life time	> 50.000 hrs
	energy efficiency class	A+
	power	30 W (incl. Occhio power supply unit approx. 36 W)
	color rendering index	high color; CRI Ra 95
	color temperature	2700–4000 K
	recommended use	residential, commercial, office
electricity	dimming	via trailing-edge phasecut dimmer*, Occhio air or DALI
	connection	230 V AC / 50 Hz
	permitted operating conditions	max. 30°C for indoor use only

* For a list of compatible dimmers, see www.occhio.de/dim_en, trailing-edge phasecut dimmer, Occhio air and DALI not combinable



Mito alto side 70 lighting effects

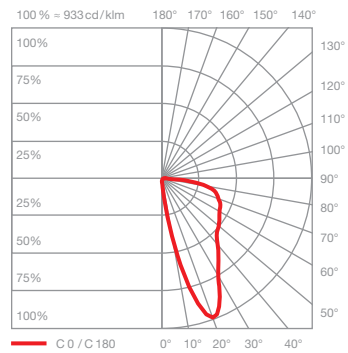
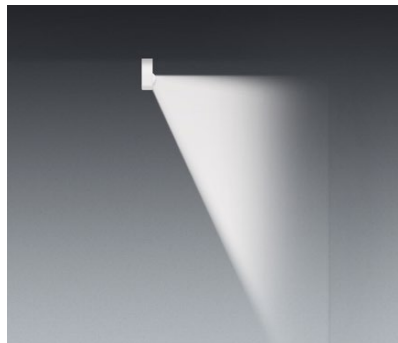

side

concentrated light, beam angle approx. 50°

inserts: wallwash

luminous flux: high color 30 W 1600lm

Mito alto side 70 connection diagram

A maximum of 64 Mito alto units can be assigned to each DALI circuit.

The Mito alto units can be organized into as many as 16 groups and equipped with an additional 16 scenarios (predefined settings).

Using a DALI short address, they can be actuated and configured individually. In addition, the bi-directional data transfer lets users query the state/status of individual luminaires.

You can find more detailed information at www.occhio.de/dali.

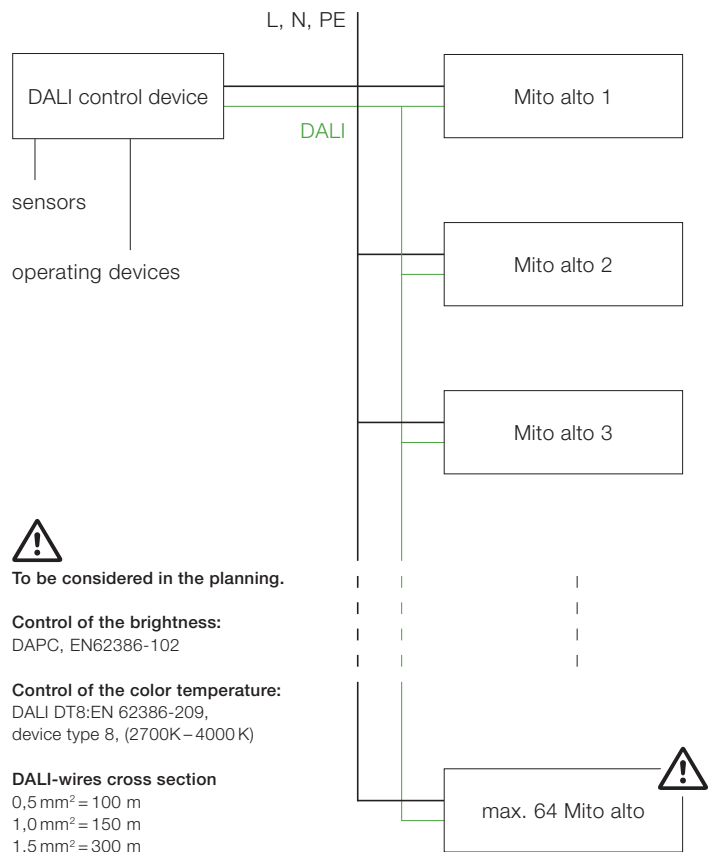

control options

control

Mito set box (standard)

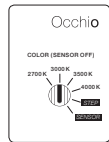

sospeso / volo

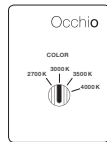

soffitto / alto flat



alto & alto side

sospeso / volo:

COLOR (Sensor off)
adjustable color temperature (4 steps)
trailing-edge phase cut dimming possible

alto / alto side:

COLOR
adjustable color temperature (4 steps)
trailing-edge phase cut dimming possible

STEP

adjustable color temperature (4 steps)
adjustable up / downlight ratio (5 steps)
trailing-edge phase cut dimming possible

SENSOR

»touchless control« (gesture control)
switching, dimming, up / down fading
color tune (color temperature continuously adjustable)
no external dimming possible

Mito »air« box (optional)



sospeso / volo



alto & alto side



Occhio air (Bluetooth control using Occhio air app) or air controller (optional)
control of individual luminaires, groups and scenes

sospeso / volo:

SENSOR
»air« + »touchless control« (Bluetooth- und gesture control)
control via »touchless control« and Occhio air app or air controller

SENSOR OFF

»air«
control via Occhio air App or air controller
switching, dimming, up / down fading
color tune (color temperature continuously adjustable)



terra / terra 3d /
terra table top /
soffitto / alto flat

**Occhio air
powered by
Casambi**

terra / terra 3d / terra table top:

»air«, »touchless control« and »body sensor«
(Bluetooth- und gesture control)
control via »touchless control«, »body sensor«
and Occhio air App or »air« controller

alto / alto side:

»air« (Bluetooth - control)
control via Occhio air App or »air« controller
switching, dimming
color tune (color temperature continuously adjustable)

»ambient light control«
adjustment to ambient light

»presence sensor«
presence identification and automatically
shutdown by presence sensor

deactivation and adjustable via control
and sensor with air app

with Mito air box no external dimming possible

Mito DALI box (optional)



sospeso / volo /
soffitto alto flat



alto up & alto side up



alto & alto side

control via DALI

sospeso / volo / soffitto / alto flat

- color tune adjustable**
- adjust continuously dimming
- up + downlight separate controllable (two DALI addresses needed)
- no »touchless control«, no fading
- volo 100 (max. 22,5 W uplight / 22,5 W downlight)
- volo 140 (max. 30 W uplight / max. 30 W downlight)

alto / alto side

- color tune adjustable**
- continuously dimming

** DALI controller DALI Device type 8 (DT8) for controlling of the color tune necessary
further signs on www.occhio.de/dali