

# SOLID

25-May-2019

## 1.0 LED

LED 8W | 220-240VAC | 50-60Hz | COB 3-step |incl. PS | phase-cut dim

CE IP20 0,9m 36° 25°/25° 355°

|                       |         |
|-----------------------|---------|
| white texture         | 133164W |
| white texture + gold  | 133164J |
| black texture + gold  | 133164K |
| copper +black texture | 133164P |
| black texture         | 133164B |
| bronze+black texture  | 133164Q |

### LIGHT COLOUR

|                             |   |
|-----------------------------|---|
| 2700K   >90CRI   470lm      | 3 |
| 3000K   >90CRI   470lm      | 5 |
| 1800-2850K   >95CRI   410lm | 9 |

## 1.0 PAR16

PAR16 max. 12W | GU10 | 100-240VAC | 50-60Hz

CE IP20 0,9m 25°/25° 355°

|                       |          |
|-----------------------|----------|
| white texture         | 133120W0 |
| white texture + gold  | 133120J0 |
| black texture + gold  | 133120K0 |
| copper +black texture | 133120P0 |
| black texture         | 133120B0 |
| bronze+black texture  | 133120Q0 |

OPTIONAL  
for PAR16 lamps see our catalogue

base plate dimensions

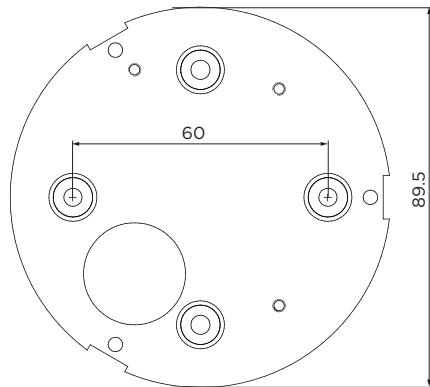

### 1.0 LED

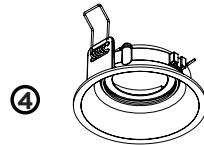
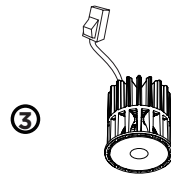
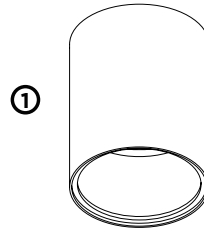

### 1.0 PAR16

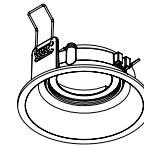
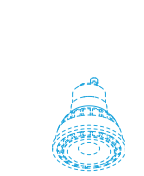
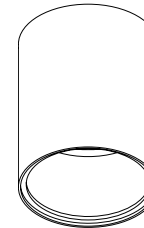

## DIMENSIONS



1.0 LED



1.0 PAR16

## 1 MOUNTING INSTRUCTION

Attach the SOLID base plate to the ceiling with screws.

## 2 POWER CONNECTION

Connect to power  
Interior connection : standard version

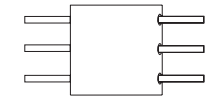

3 Insert the light module (PAR16/LED ENGINE) into the module and fix with spring.

4 Click the module into the SOLID base fixture with the springs.

