

installation method of 1.0/2.0/3.0/4.0

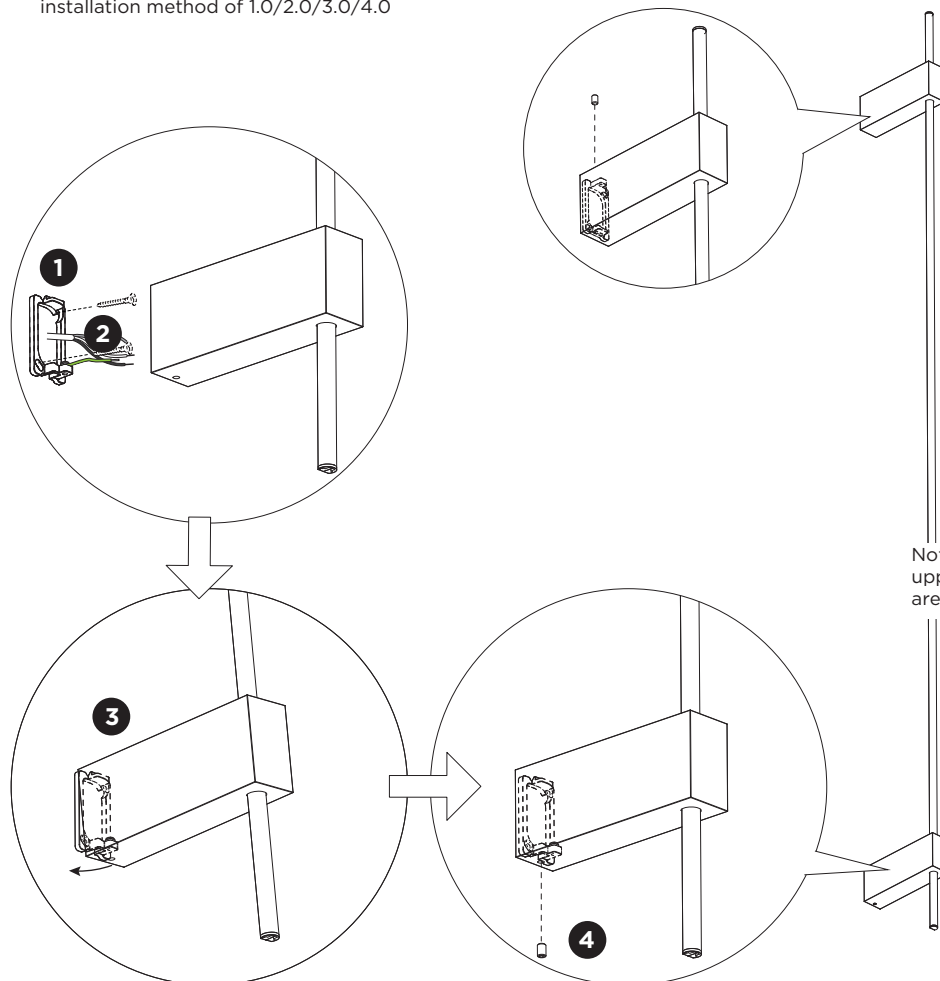

Note: for 3.0, the direction of the upper and lower mounting bases are symmetrical to each other.

DIMENSIONS

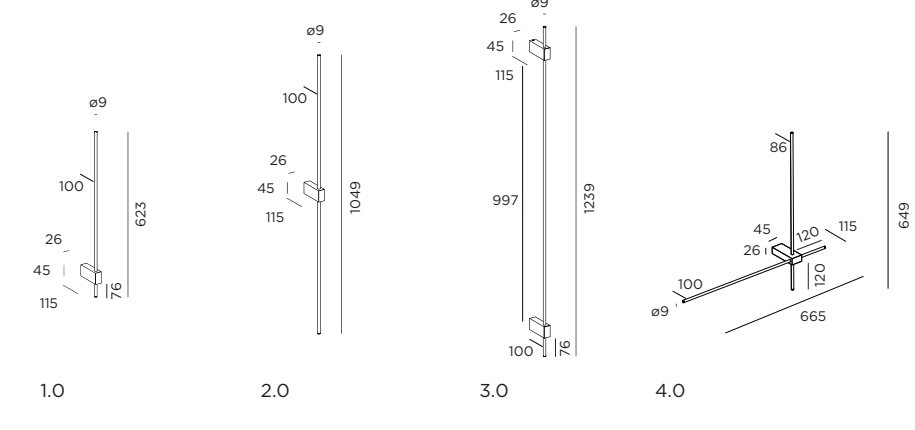

Mounting base:

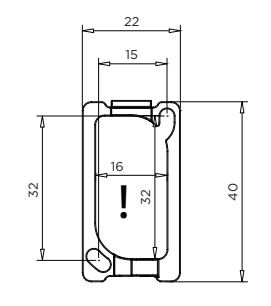

MOUNTING INSTRUCTION

- 1 Remove the mounting base from the luminaire by loosening the socket screw and mount it on the wall with screws (screws are not included).
- 2 **POWER CONNECTION**
Connect to 220-240V.

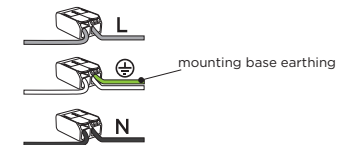

- 3 Attach the luminaire to the mounting base with the upper side first and tilt towards the wall as shown.
- 4 Fixate the luminaire on the base with the socket screw.

PB19-010-688-00_v0