



Catellani & Smith®



Macchina della Luce

LED dimmable

pendant

ISTRUZIONI DI MONTAGGIO / ASSEMBLY INSTRUCTIONS / INSTRUCTIONS DE MONTAGE / MONTAGEANLEITUNGEN / INSTRUCCIONES DE MONTAJE

I AVVERTENZE

- Si raccomanda che l'installazione venga eseguita da un elettricista abilitato.
- Togliere la tensione di alimentazione prima di effettuare l'installazione e per interventi di manutenzione o in caso di cattivo funzionamento.
- Si consiglia l'utilizzo dei guanti in dotazione. Per la pulizia della superficie utilizzare un piumino rimuovi-polvere.

GB WARNINGS

- Only a qualified electrician should execute the installation.
 - Switch off the power supply before installing, servicing or in case of malfunctioning.
 - We suggest you to use the gloves provided. We recommend using a feather duster to clean the surfaces.
-

I classe class	IP20 classe di protezione protection class	 persone suggerite per il montaggio people required for mounting	 MADE IN ITALY
----------------------	--	---	--

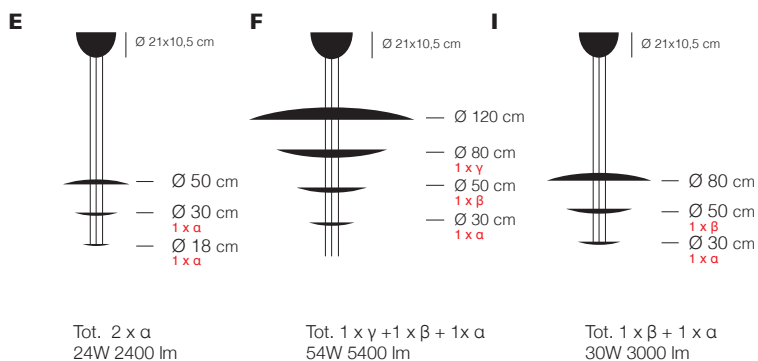
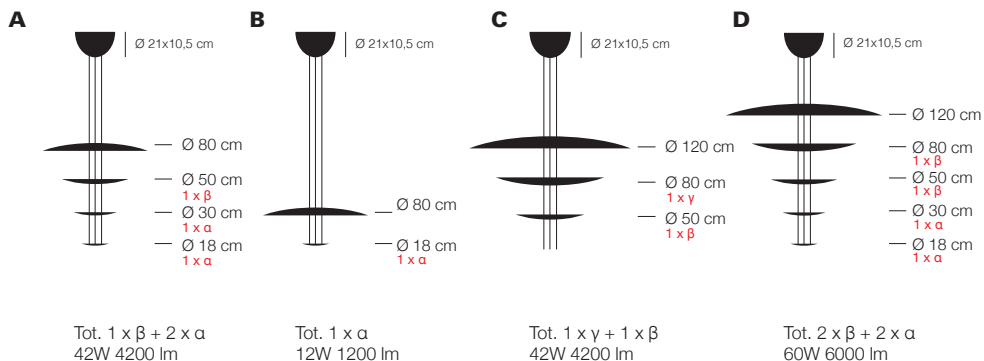

LED boards 24V DC

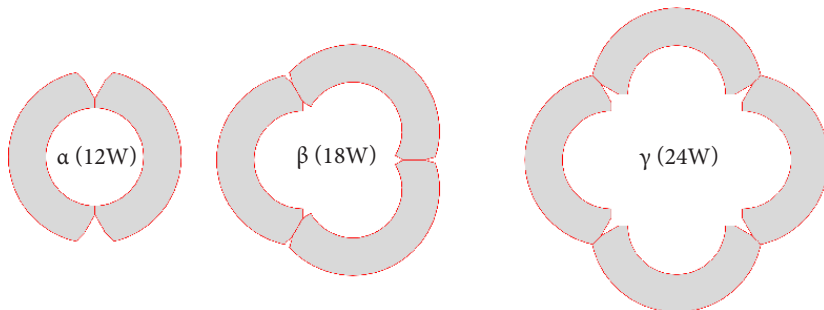

dimmerazione / dimming

con dimmer compatibili Triac
with Triac compatible dimmer

A distanze dei dischi consigliate
recommended discs distances

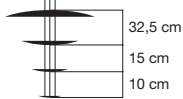

lampadine / bulbs	trasformatore / transformer	dimmerazione / dimming
Schede LED 7x6W	elettronico 24V DC 60W	Triac
LED Boards 7x6W	electronic 24V DC 60W	Triac

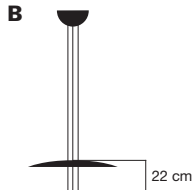

lampadine / bulbs	trasformatore / transformer	dimmerazione / dimming
Schede LED 2x6W	elettronico 24V DC 60W	Triac
LED Boards 2x6W	electronic 24V DC 60W	Triac

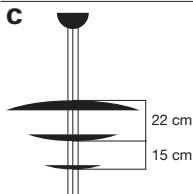

lampadine / bulbs	trasformatore / transformer	dimmerazione / dimming
Schede LED 7x6W	elettronico 24V DC 60W	Triac
LED Boards 7x6W	electronic 24V DC 60W	Triac

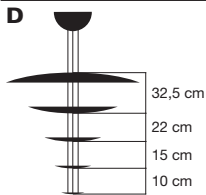

lampadine / bulbs	trasformatore / transformer	dimmerazione / dimming
Schede LED 10x6W	elettronico 24V DC 60W	Triac
LED Boards 10x6W	electronic 24V DC 60W	Triac

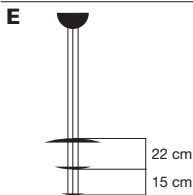

lampadine / bulbs	trasformatore / transformer	dimmerazione / dimming
Schede LED 4x6W	elettronico 24V DC 60W	Triac
LED Boards 4x6W	electronic 24V DC 60W	Triac

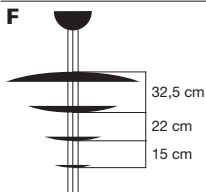

lampadine / bulbs	trasformatore / transformer	dimmerazione / dimming
Schede LED 9x6W	elettronico 24V DC 60W	Triac
LED Boards 9x6W	electronic 24V DC 60W	Triac

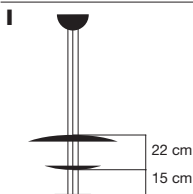

lampadine / bulbs	trasformatore / transformer	dimmerazione / dimming
Schede LED 5x6W	elettronico 24V DC 60W	Triac
LED Boards 5x6W	electronic 24V DC 60W	Triac



DANGER
low voltage connection



Si raccomanda che l'installazione venga effettuata da un elettricista abilitato. Si prega di controllare che tutte le connessioni siano eseguite con attenzione. Una connessione non corretta può generare un surriscaldamento dei collegamenti.

Only a qualified electrician should execute the installation. Please make sure that the connections are made up to standard. A faulty connection can lead to the overheating of the junctions.

On recommande que l'installation soit faite par un électricien diplômé. Bien vérifier que les branchements soient effectués avec soin. Un branchement mauvais peut conduire au surchauffage des connexions.

Es wird empfohlen, die Installation durch einen staatlich geprüften Elektriker ausführen zu lassen. Bitte kontrollieren, dass die Verbindungen mit Aufmerksamkeit ausgeführt werden. Jeder falsche Anschluss kann der Überhitzung des Verbindungen verursachen.

Se recomienda que la instalación sea efectuada por un electricista habilitado. Hay que verificar que todas las conexiones eléctricas hayan sido correctamente realizadas. Un enlace incorrecto puede causar un calentamiento excesivo de las conexiones.

MONTAGGIO ROSONE Ø 21 cm
CANOPY Ø 21 cm MOUNTING

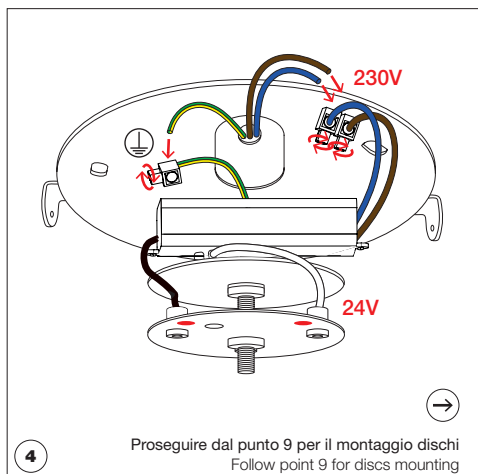
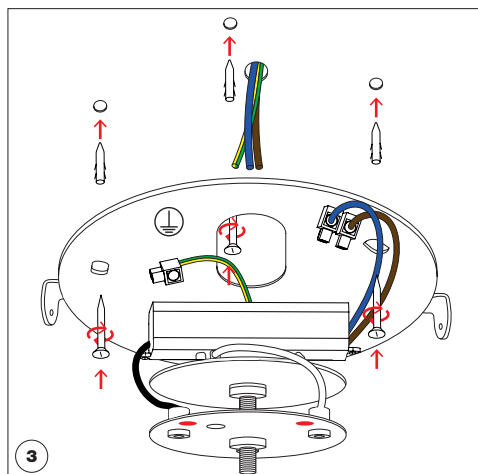
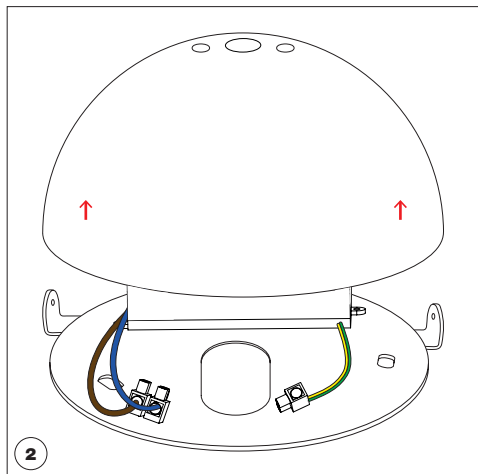
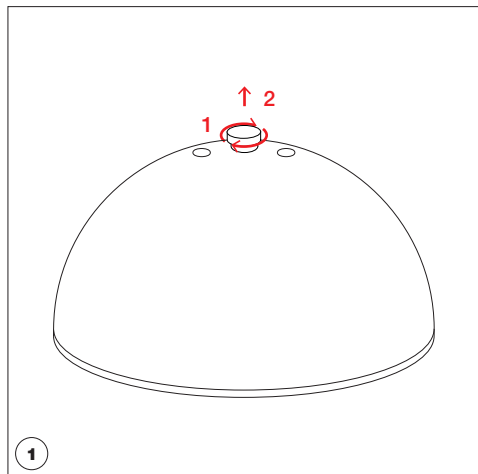

Proseguire dal punto 9 per il montaggio dischi
Follow point 9 for discs mounting

MONTAGGIO ASTE RODS MOUNTING

5

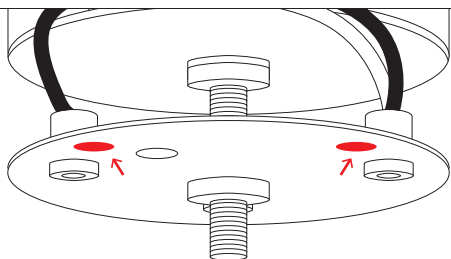
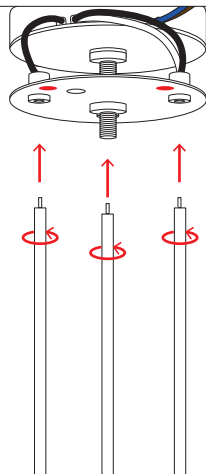

ATTENZIONE: le aste elettrificate alle quali collegare i porta lampada sono identificate con un bollino rosso (vedi punto 21)

WARNING: the electrified rods for the lamp holders supply are identified with a red mark (see point 21)

6

7

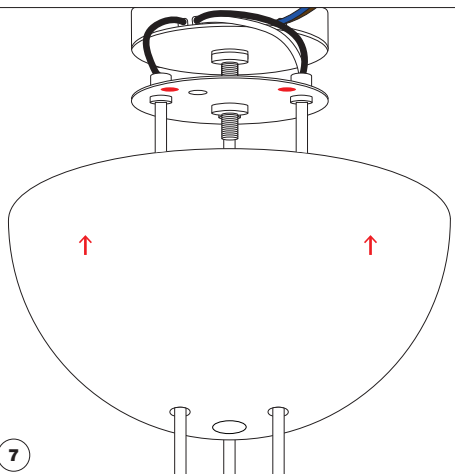

8

MONTAGGIO DISCHI DISCS MOUNTING

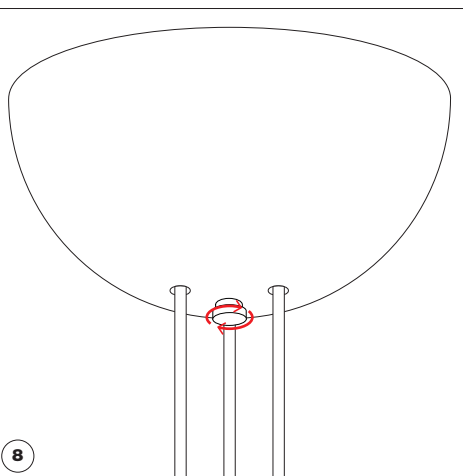

Decidere l'altezza totale della lampada e tagliare le aste
Decide the lamp total height and cut the rods

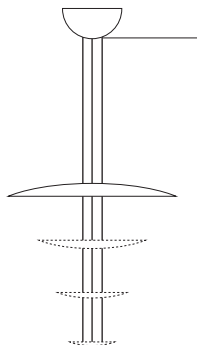

H variabile
H variable

vedi distanze dischi
consigliate p. 2
see recommended discs
distances p. 2



9

Montaggio primo disco
First disc mounting



10

Montaggio dischi
centrali e ultimo disco
mod. C - F
Central and last discs
mounting mod. C - F

LED board

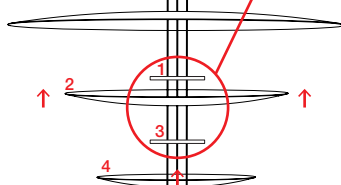

12

11

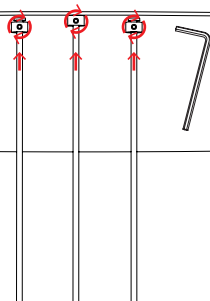

13

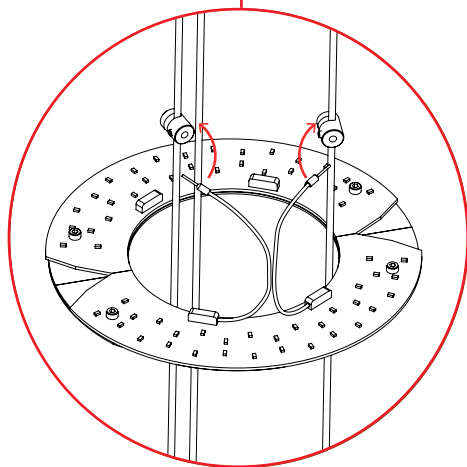
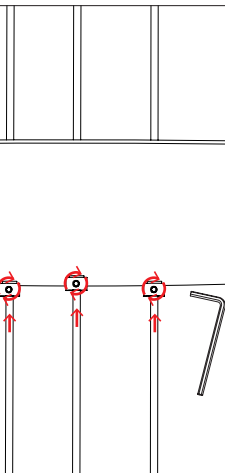

www.catellanismith.com



Catellani & Smith®



Questa apparecchiatura non deve essere smaltita come un normale rifiuto urbano, ma deve essere portata nel punto di raccolta appropriato per il riciclaggio di apparecchiature elettriche ed elettroniche. Provvedendo a smaltire questo prodotto in modo appropriato, si contribuisce ad evitare potenziali conseguenze negative per l'ambiente e per la salute umana, che potrebbero derivare da uno smaltimento inadeguato del prodotto. Per informazioni più dettagliate sul riciclaggio di questo prodotto, contattare l'ufficio comunale, il servizio locale di smaltimento rifiuti o il rivenditore presso il quale è stato acquistato il prodotto.

This equipment may not be treated as household waste. Instead it shall be handed over to the applicable collection point for the recycling of electrical and electronic equipment. By ensuring this product is disposed of correctly, you will help prevent potential negative consequences for the environment and human health, which could otherwise be caused by inappropriate waste handling of this product. For more detailed information about the recycling of this product, please contact your local city office, your household waste disposal or the dealer where you purchased this product.

