

# Arcipelago

Servomuto



SO



TA



La collezione Arcipelago è composta da lampade a sospensione e da tavolo, caratterizzate dal diffusore ignifugo Trevira CS con frange e corpo in ottone satinato, dettagli che arricchiscono il prodotto. La sorgente luminosa è una piastra LED personalizzata e dimmerabile, che può essere regolata tramite un regolatore trifase sulla base nella versione da tavolo.

*The Arcipelago collection is composed of suspension and table lights, characterised by the Trevira CS fire-resistant shade with fringes and a satin brass body – details that enrich the product. The light source is an LED customised and dimmable plate, which can be regulated through a three-phase dimmer switch on the base in the table version.*

SPECIFICHE PRODOTTO / PRODUCT SPECIFICS

p.2

ARCIPELAGO SO  
ARCIPELAGO TA

p.3

p.4

**STRUTTURA / FRAME**

Finitura ottone satinato  
*Satin brass finish*

**FRANGE / FRINGES**

Franghe verde salvia  
*Sage green colour fringes*



Franghe ruggine  
*Rust colour fringes*



Franghe cognac  
*Cognac colour fringes*



Franghe sabbia  
*Sand colour fringes*



Franghe aragosta  
*Aragosta (bright orange) fringes*



Franghe blu nebbia  
*Fog blue colour fringes*

**MANUTENZIONE E PULIZIA****STRUTTURA**

Utilizzare un panno asciutto per pulire la struttura della lampada.

**FRANGE**

Le frange del modello Arcipelago sono lavabili. Conservare il sacchetto per il lavaggio. Immergere, dentro il sacchetto, le frange in acqua a 30° e detersivo. Sciacquare sotto acqua corrente. Appendere ancora bagnato. Nel caso le frange si accorcino dopo il lavaggio, stirare con ferro tiepido (temperatura per seta).

Franghe ignifughe: CLASSE UNO IM - BS EN 10211:2006 CIGARETTE TEST - BS EN 10212:2006 BUTANE FLAME TEST - NPFA 260:CLASS 1 IMO A0652(16) - CIGARETTE TEST AND BUTANE TEST

**MAINTENANCE AND CLEANING****FRAME**

Use a dry cloth to clean the frame of the lamp.

**FRINGES**

The fringes of the model Arcipelago are washable. Keep the bag for washing. Immerse the fringes inside the bag in water and clean it at the temperature of 30°C. Rinse with flowing water. Hang while still wet. In case the fringes get shorter after washing, iron with warm iron (use the temperature for silk).

Fire-resistant fringes: CLASSE UNO IM - BS EN 10211:2006 CIGARETTE TEST - BS EN 10212:2006 BUTANE FLAME TEST - NPFA 260:CLASS 1 IMO A0652(16) - CIGARETTE TEST AND BUTANE TEST

**CAVO - INTERRUTTORE / CABLE - SWITCH**

Tessuto nero  
*Black fabric*

**TA**

Pulsante a tre intensità sulla base (100 - 70 - 30%)  
*Three step push switch on the base (100 - 70 - 30%)*

H: 2000 mm  
*H: 78.7"*

**SO**

L: 2000 mm  
*L: 78.7"*

**FONTE LUMINOSA / LIGHT SOURCE****220-240V**

○ Custom LED

1 x 12W  
Custom LED  
Emission: 1.800 Lm  
3.000 K; CRI: >90  
IP20



□ Arcipelago TA

**110V**

○ Custom LED

1 x 12W  
Custom LED  
Emission: 1.800 Lm  
3.000 K; CRI: >90  
IP20

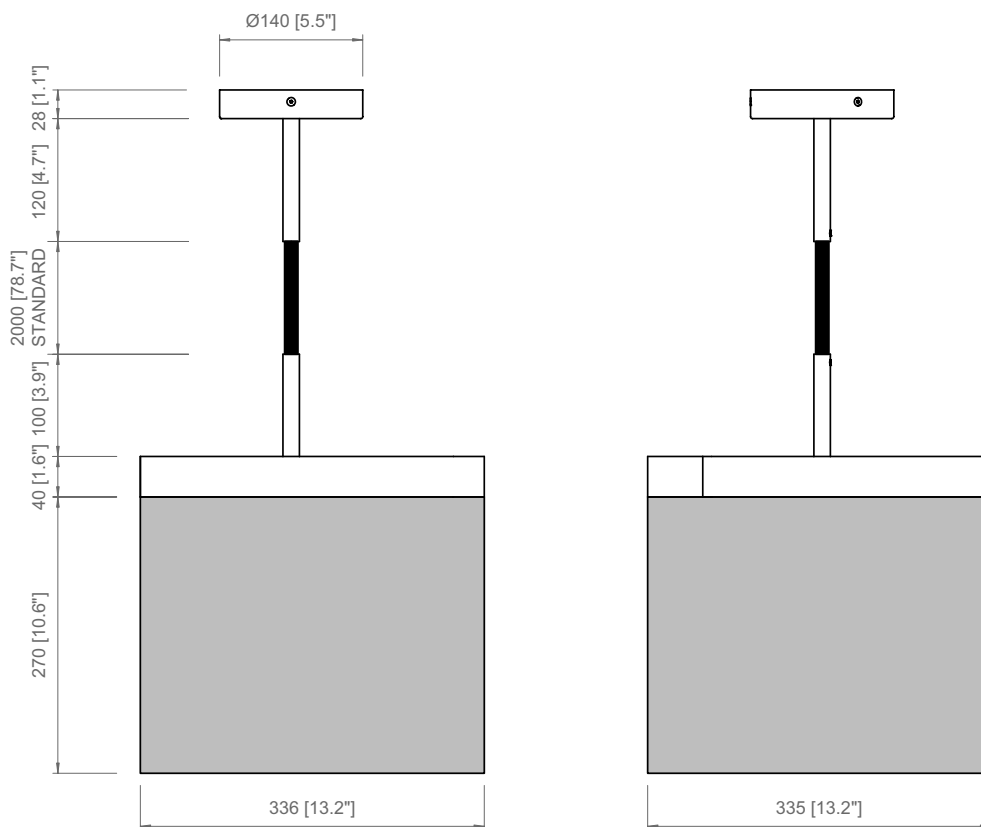
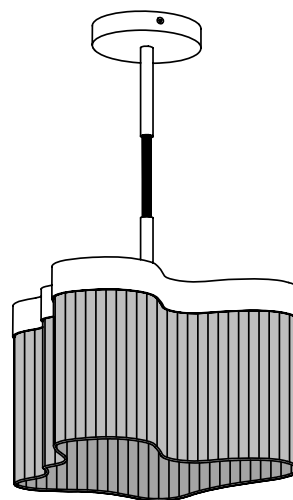
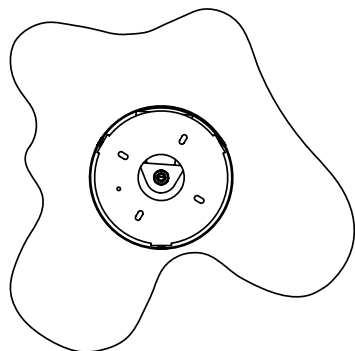

**PRODOTTO / PRODUCT    IMBALLI / PACKAGING**

<p><b>Peso-Weight</b> 7 kg / 15.4 lbs</p>	<p><b>Box 1</b> L: 380 mm / 14.9" P-W: 420 mm / 16.5" H: 480 mm / 18.9" Peso-Weight: 6 kg / 13.2 lbs</p>
---	--

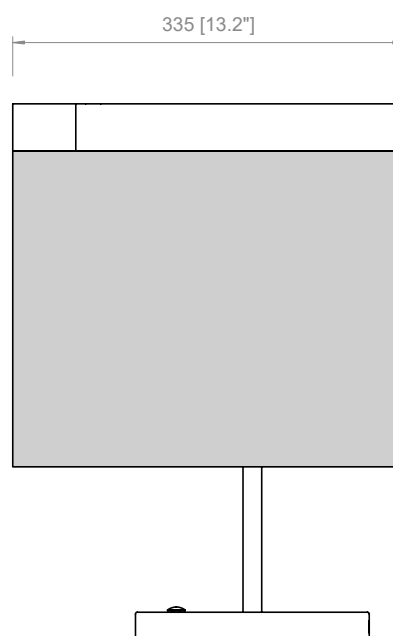
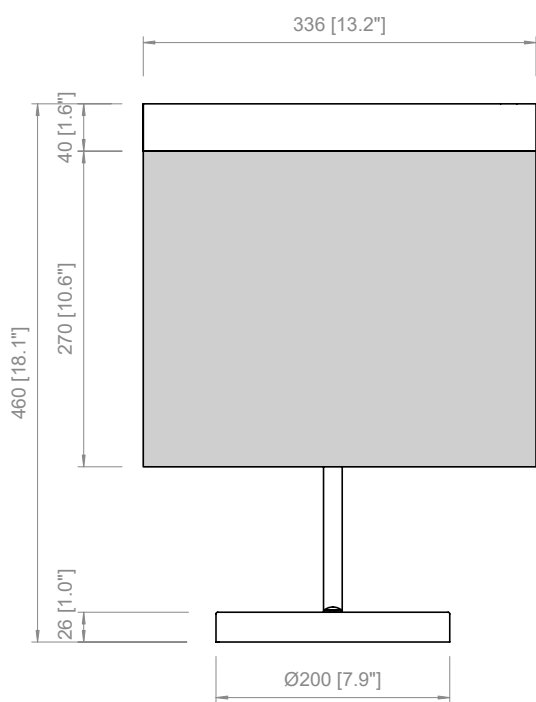
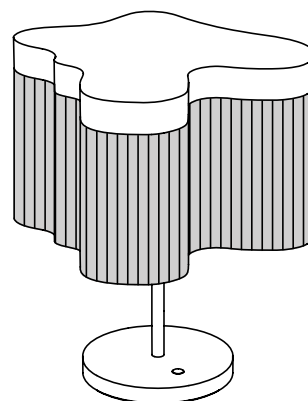
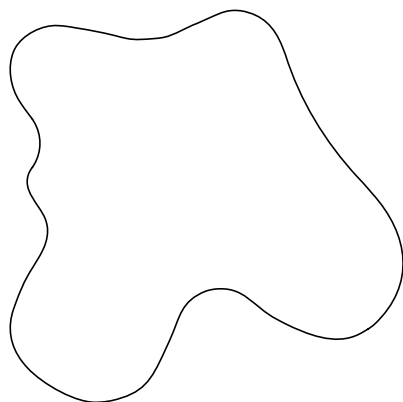

**PRODOTTO / PRODUCT    IMBALLI / PACKAGING**

<p><b>Peso-Weight</b> 5 kg / 11 lbs</p>	<p><b>Box 1</b> L: 410 mm / 16.1" P-W: 410 mm / 16.1" H: 610 mm / 24" Peso-Weight: 8 kg / 17.6 lbs</p>
---	--

Copyright and/or design rights subsist in this drawing. No part of this drawing may be reproduced in any material form (including photocopying or storing in any medium electronic means, whether or not intentionally and whether or not as part or a larger publication) without the express permission of the copyright owner, Contardi Lighting S.r.l.. Further and without prejudice to the above, this drawing and all information relating thereto is confidential, and shall not be communicated to a third party without the consent of Contardi lighting srl. Contardi lighting srl asserts all rights to be identified as the author of the work and otherwise.

WARNING: The doing of any unauthorised act in relation to a copyright work may result in both a civil claim for damages and criminal prosecution.

---

**CONTARDI LIGHTING Srl**

ITALY HEADQUARTERS

[www.contardi-italia.com](http://www.contardi-italia.com) / [sales@contardi-italia.it](mailto:sales@contardi-italia.it)

**CONTARDI USA Inc**

USA BRANCH

[www.contardi-usa.com](http://www.contardi-usa.com) / [sales@contardi-usa.com](mailto:sales@contardi-usa.com)

