

EARTH

Un cœur lumineux, serti d'un métal ajouré de manière extrêmement fine ou d'un disque plein, confère à cette collection une touche Art déco. Du clair-obscur au moucharabieh, les idées de composition sont variées.



This wall light, with an illuminated center, assembled with an extremely fine openwork or a fully covered piece of metal gives this collection an Art déco style. From semi-darkness to a patterned light source, arrangements can vary.



Finitions
Finishes ①+②

● Laiton satiné
SB Satin brass

● Graphite satiné
SG Satin graphite

● Nickel satiné
SN Satin nickel

● Cuivre satiné
SC Satin copper

Matériaux
Material

Laiton massif
Solid brass

Diffuseur en polycarbonate
Polycarbonate diffuser

Source
Lamping

LED intégrée
Integrated LED

1080 lm
1080 lm

2700°K
2700°K

Alim. électronique 24 V intégrée
Integrated 24 V power supply

Variation. Veuillez nous contacter
Dimming. Please, contact us



Designer

Émilie Cathelineau

Earth Sober

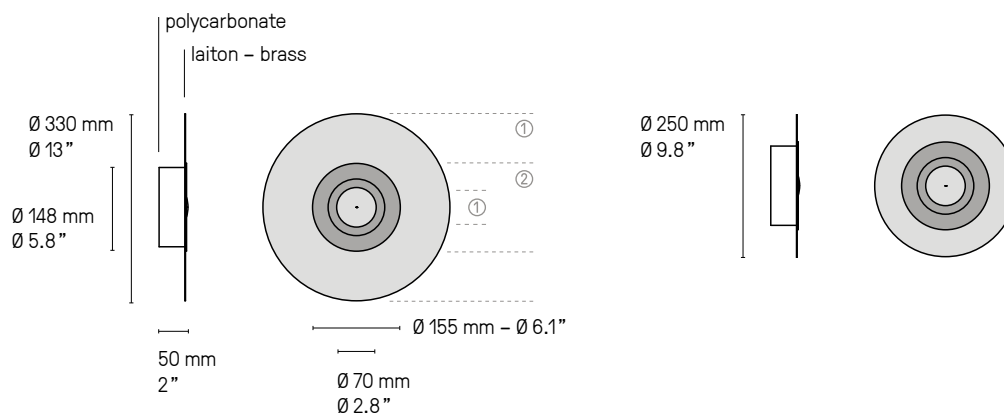

Partie centrale identique pour tous les modèles, quels que soient la taille et le motif.
Identical central part for all *Earth* fixtures for any size and design.

Earth Sun

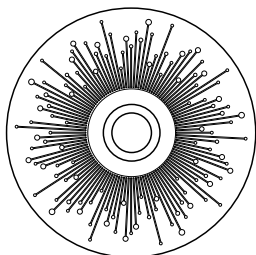

Ø 440 mm
Ø 17.3"

Disponibile en Ø 330 mm
Available in Ø 13"

Earth Palm

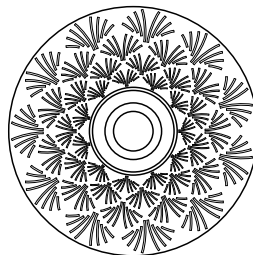

Ø 440 mm
Ø 17.3"

Disponibile en Ø 330 mm
Available in Ø 13"

Earth Mandala

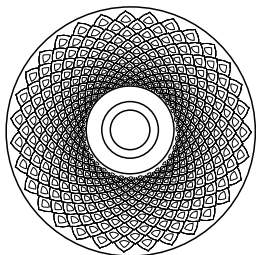

Ø 440 mm
Ø 17.3"

Disponibile en Ø 330 mm
Available in Ø 13"

Earth Turtle

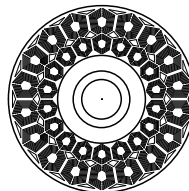

Ø 330 mm
Ø 13"

Disponibile en Ø 440 mm
Available in Ø 17.3"

Earth Radian

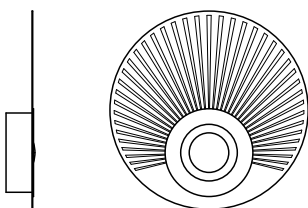

Ø 350 mm
Ø 13.8"



Earth Sober 330 SB/SG



Earth Radian 330 SB/SG

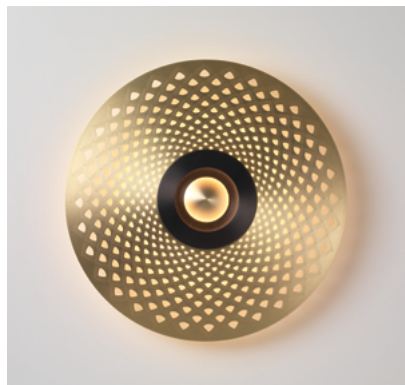

Earth Mandala 440 SB/SG



Earth Sun 440 SB/SG



Earth Palm 330 SB/SG



Earth Sun 330 SC/SG



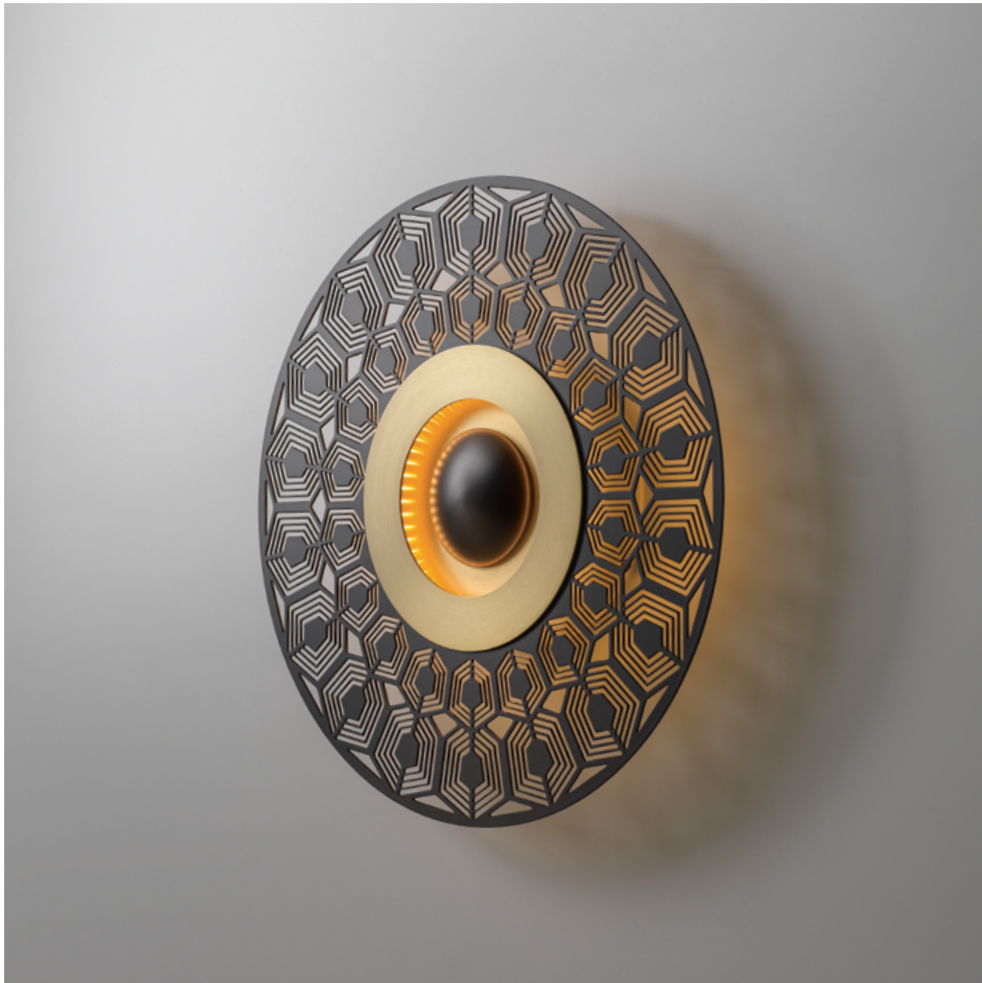

Earth Turtle 330 SG/SB



NUANCIER - FINISH OPTIONS



LAITON - BRASS

- | | |
|-------------------------------------|---|
| ① Laiton satiné
SB Satin brass | ② Graphite satiné
SG Satin graphite |
| ③ Nickel satiné
SN Satin nickel | ④ Cuivre satiné
SC Satin copper |
| ⑤ Laiton poli
PB Polished brass | ⑥ Graphite poli
PG Polished graphite |
| ⑦ Nickel poli
PN Polished nickel | ⑧ Cuivre poli
PC Polished copper |

ABAT-JOURS - LAMPSHADES



Drop Paper® 100



Drop Paper® 101

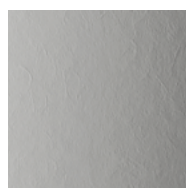

Drop Paper® 103

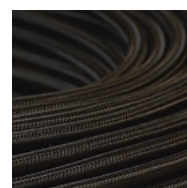

Tissu noir
Black textile



Chinette blanche
White chinette

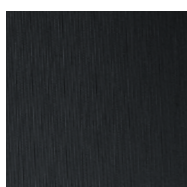

Chinette noire
Black chinette

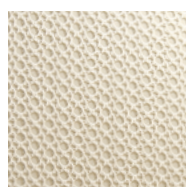

Duke
Duke



Tissu or
Gold textile

VERRERIE - GLASS



Opale
Opal

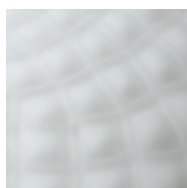

Opale et écaille
Opal and patterned



Claire et écaille
Clear and patterned

CONSEILS TECHNIQUES

Les caractéristiques techniques mentionnées dans ce document sont données à titre indicatif et sont susceptibles de subir des modifications. Ceci est lié à l'évolution rapide de la technologie LED.

Les dimensions sont approximatives et peuvent varier légèrement.

AMPOULES

Il est impératif de respecter les types et les puissances maximales préconisées sous peine de détériorer le luminaire. En cas de non-respect, la garantie ne pourra s'appliquer.

CONSEIL D'ENTRETIEN

Essuyage avec un chiffon doux, sans produits d'entretien. Nos produits étant vernis afin d'assurer la longévité du luminaire, il ne faut en aucun cas utiliser de produits détergents ou de solvants.

La société se réserve le droit de modifier, sans préavis, les caractéristiques de ses produits.

TECHNICAL ADVICE

The technical characteristics provided in this document are for information purposes only and are subject to change, due to permanent evolution of LED technology.

All dimensions are approximate and may vary slightly.

LIGHT BULBS

Use only the type of light bulb and maximum wattage shown otherwise you may damage the light fitting. Failure to use the correct light bulb and wattage will affect the warranty.

CARE INSTRUCTIONS

Wipe with a soft cloth –do not use any cleaning products. All our light fittings are lacquered to ensure the longevity of the product– under no circumstances use detergents or solvents.

The company reserves the right to modify its products at any time without notice.

CVL LUMINAIRES

79 ROUTE DE LA CHEVALLERIE – 49770 LONGUENÉE-EN-ANJOU – FRANCE

TEL. +33 (0) 2 41 32 67 54 – FAX +33 (0) 2 41 32 76 62

EMAIL : CONTACT@CVL-LUMINAIRES.FR

WWW.CVL-LUMINAIRES.FR